







www.RolkoShop.dk

Rolko Scandinavia

Tlf. 8720 1888 - www.rolkoshop.dk - info@rolko.dk

Version 2025.1

Virksomhed Company	03		
Informationer Information	04		
Hjælpe midler Daily Aids	06		
Ramper Ramps	06	 	
Sengeløfter	08		
Hjælpe midler og tilbehør Aids and accessories	09		
Tasker til kørestole Bags for Wheelchairs	12		
TermoPro og RainPro TermoPro And RainPro	14	 	
Kørestolspuder Wheelchain Seat Cushions	21		
Scooter og rollator tilbehør Scooter and walker Accessories	23		
Hofte- og skuldreseler Hip and Shoulder Belts	29		
Lægremme, Hælremme og antitip hjul Calf Straps, Heel Straps, Anti-tip Wheel	33		
Bremser og tilbehør Brakes and Accessories	34		
Håndtag og rørovertræk Hand Grips and Tube Covers	38		
Egerbeskyttere Spoke Guards	40		
Fodstøtter og -remme Foot Rests and Belts	41		
Rollator-bakke Rollator Tray	42		
Drivringe og tilbehør Push Rim and Accessories	44		
Hjul Wheels			
Egerhjul Spoke Wheels	46		
Svinghjul Caster Wheels	48		
CoMoRun hjul CoMoRun Wheels	52		
Rollatorhjul Rollator Wheels	53		
Dæk Tyres	56		
Dæktilbehør Tyre Accessories	57		
Polyurethan-dæk Polyurethane Tyres	58		
Dæk til manuelt betjente kørestole Tyres for Manually Operated Wheelchairs	60		
Slanger Tubes	68		
Punkeringssikre dæk Puncture proof tyres	70		
Dæk til el-kørestole og scootere Tyres for Power Chairs and Scooters	71		
Terapiborde Therapy tables	76		
Tilbehør til toiletstole Toilet chair Accessories	78		
Sengehjul Wheels for beds	80		
Dropstativer Equipment Rods	81		
Armlæn og tilbehør Arm rests and accessories	83		
Triangelgreb Trapeze handles	85		
Hovedstøtter og holdesystemer Head Rests and Restraining Systems	86		
Sidestøtte og holdesystemer MDR Godkendt Side pads and retaining systems	88		
Modulært armstøttesystem HEMI Modular Arm Shell System HEMI	90		
Aksler, Kuglelejere, div Assembly Accessories	92		

Virksomhed | Company

Rolko Gruppen er en af de førende udbydere af komponenter og tilbehørsdele til rehabiliteringsbranchen samt mobilitetsløsninger til forskellige brancher i industrien. Med hovedsæde i Tyskland, afdelinger i Danmark, Holland og USA samt en fabrik i Kina sørger virksomheden for rådgivning, service og levering i hele Verden.

Producenter og forhandlere fra mere end 80 lande sætter deres lid til det omfangsrige produktsortiment fra Rolko. Dette omfatter hjul, dæk, punkteringssikre løsninger og yderligere produkter til kørestole og rehabiliteringsudstyr. Vi har også hjælpemidler til rehabilitering såsom kørestolsramper, beklædning til vejrbeskyttelse samt transferhjælpemidler. Derudover tilbyder Rolko komponenter til den medicinske sektor, såsom triangelgreb, fenderhjul og montageelementer til hospitalssenge. |

Rolko Kohlgrüber GmbH is a leading manufacturer and supplier of components and accessories for the rehabilitation market as well as mobility solutions for companies from various industrial sectors. With headquarters in Germany, subsidiaries in Denmark, the Netherlands and the USA as well as a production plant in China, the company ensures advice, support and delivery around the globe.

Manufacturers and specialist retailers from over 80 countries rely on the extensive delivery programme from Rolko, which includes wheels, tyres, puncture-proof solutions and further components for wheelchairs and rehabilitation equipment, rehabilitation aids such as wheelchair ramps, weather protection clothing and transfer aids. In addition, Rolko offers components for the medical sector such as sit-up aids, wall deflection rolls and holding systems for hospital and care beds.

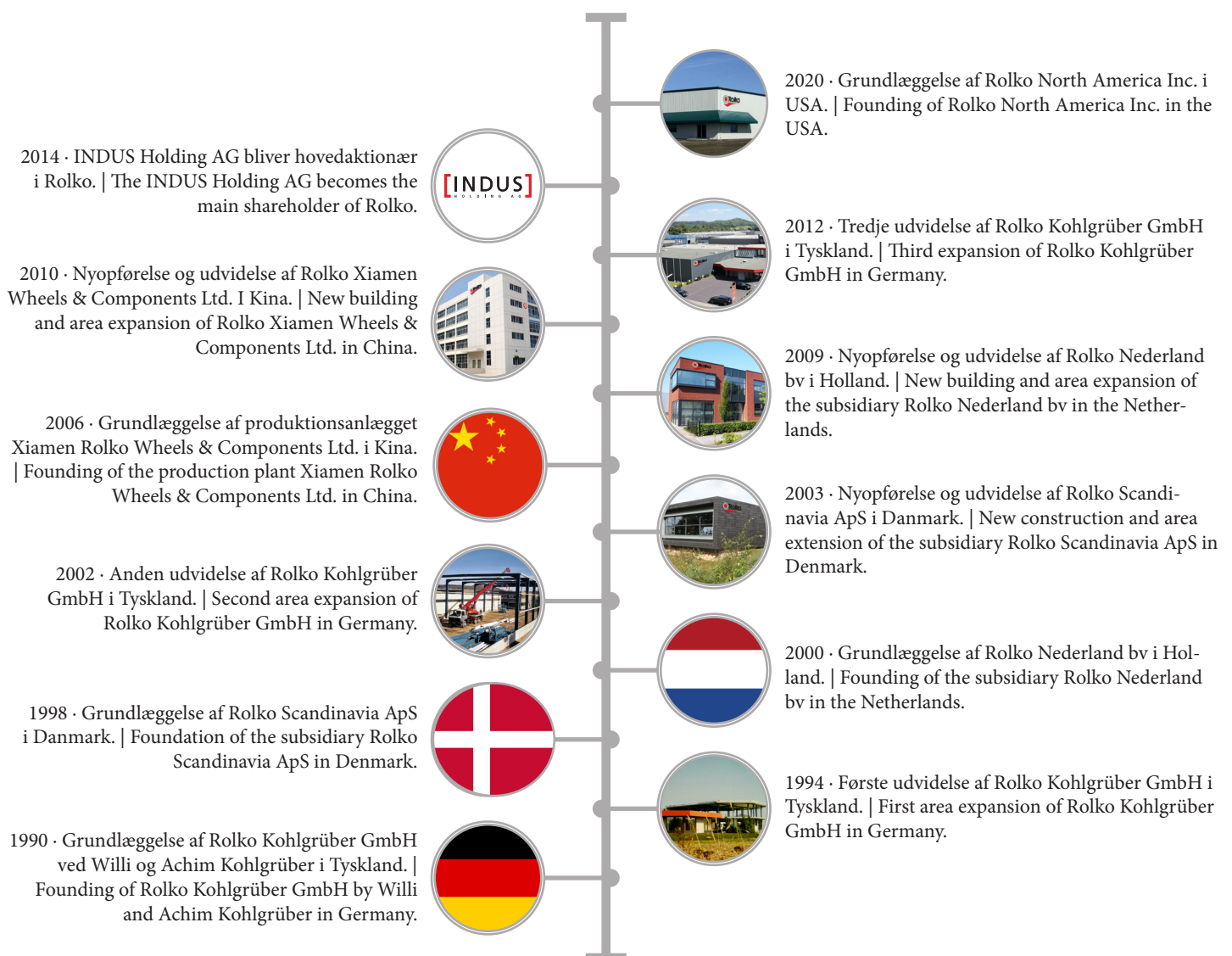

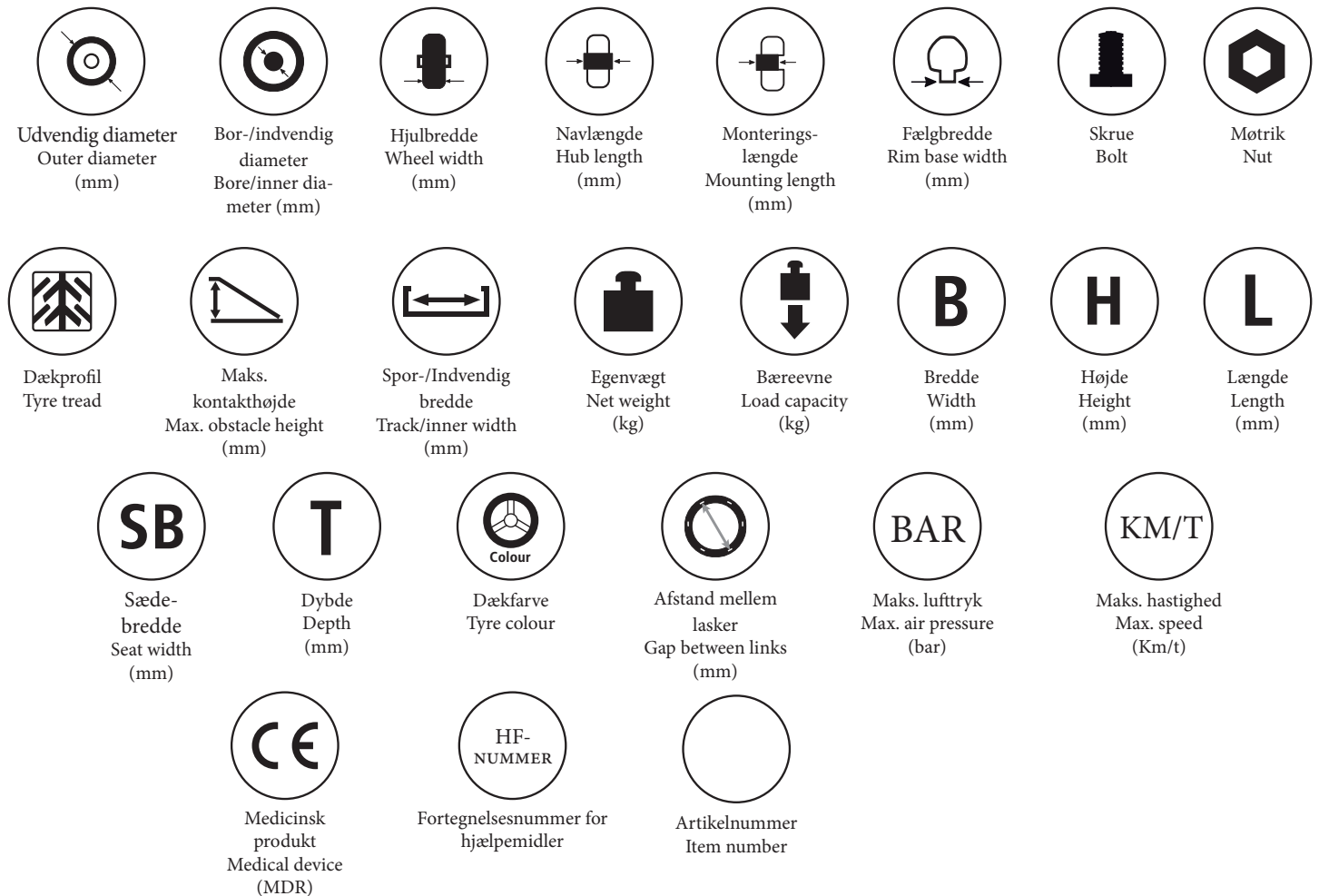

Alle mål er ca.-angivelser. Alle illustrationer er vejledende. Fejl og ændringer forbeholdes. Vi leverer i henhold til vores seneste salgs- og leveringsbetingelser. Ikke alle anførte produkter kan leveres omgående. En minimum ordremængde er påkrævet for visse produkter.

Alle billeder, grafikker og tekster i vores katalog er ophavsretligt beskyttet. Enhver anvendelse kræver vores forudgående skriftlige samtykke.

All specified dimensions are approximate. All illustrations are non-binding. We reserve the right to make unpublished/unannounced modifications. We deliver according to our latest general terms and conditions. Not all products listed are available from stock. A minimum order quantity may apply for certain products.

All images, graphics and texts in our catalogue are copyright protected. Any use requires our prior written permission.

Rolko Scandinavia

Tlf.: +45 8720 1888

Rene Rimer +45 5089 1888

John Schmidt +49 6089 0250

Bestillinger: Info@rolko.dk



Velkommen til Rolko Scandinavia ApS.

**Vi er din professionelle leverandør af reservedele & hjælpemidler i Danmark
Vi bestræber os på at levere fra dag til dag ved bestillinger foretaget inden kl. 13.
På www.rolkoshop.dk kan du foretage dine bestillinger, se priser samt se dine tidligere køb
Du kan også se alle vores produkter som ligger på HMI-basen med HMI nr.**

**Vi kan det meste og lidt til, alt sammen krydret med rigtig god service. Om det er personlig henvendelse på vores kontor i Silkeborg, via tlf eller ved en af vores 2 eksterne konsulenter.
Så møder i altid et smil og en go fag snak.**

Rolko Scandinavia ApS – kunden i centrum

Vores medicinske produkter

I henhold til forskrifterne i MDR (Medical Device Regulation) er vores medicinske produkter i dette katalog mærket med CE-symbolet. For brugsanvisninger og overensstemmelseserklæringer til vores medicinske produkter bedes du venligst gå til:



Our medical devices

In accordance with the requirements of the MDR (Medical Device Regulation), our medical products are marked with the CE symbol in this catalogue. For the instruction manuals and conformity declarations of our medical devices please visit:

 [Instruction manuals
rolko-en.com/instruction-manuals](http://rolko-en.com/instruction-manuals)

 [Conformity declarations
rolko-en.com/conformity-declarations](http://rolko-en.com/conformity-declarations)



quick2go Folderampe af aluminium Aluminium Foldable Ramp



Foldesystem med håndtag |
Folding system with handle



Skridhæmmende kontaktflade
og slidbane | Slip-resistant contact
and running surface



Mulighed for fastgørelse
på hindringen | Attachment on the
obstacle possible



					Art-Nr. Art.-No.
1820	360	714	14	300	RAMPE-K1800

*Maks. kontakthøjde ved El kørestol eller med en medhjælper. Bredde i åbnet tilstand. Højde på sideprofil: 35 mm |
*Max. obstacle height for powered wheelchairs or use with a helper. Width in opened state Side wall height: 35 mm

quick2go Fast rampe af aluminium Aluminium Loading Ramp

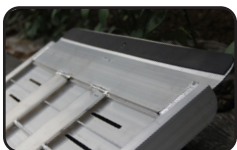

Skridhæmmende kontaktflade og
slidbane | Slip-resistant contact and
running surface



Mulighed for fastgørelse på hindringen
| Attachment on the obstacle possible



					Art-Nr. Art.-No.	HMI Nr
600	120	750	4,5	300	RAMPE-A600	102596
900	180	750	6,7	300	RAMPE-A900	102597
1200	240	750	9,2	300	RAMPE-A1200	102598
1500	300	750	13	300	RAMPE-A1500	102599

*Maks. kontakthøjde ved el kørestol eller med en medhjælper. Højde på sideprofil: 35 mm |
*Max. obstacle height for powered wheelchairs or use with a helper. Side wall height: 35 mm

quick^{2go} Aluminium teleskop ramper Aluminium Telescopic

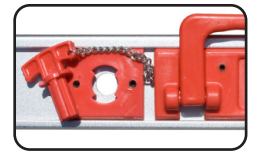

Låse pin | Lock pin



Klemmemekanisme | Clamping protection

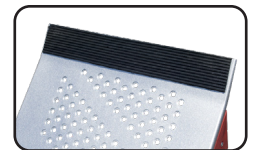

Anti-slip på anlægsflade | Slip-resistant contact surface

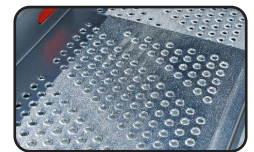

Prepered overflade | Perforated running surface

1-delig 1-piece	1100	220	210	6,8	300	- RAMPE-T1
2-delig 2-piece	1100-2000	400	195	13	300	- RAMPE-T2
3-delig 3-piece	1100-2850	570	170	18,6	260	- RAMPE-T3

Dørtrinrampe aluminium | Threshold ramps made of aluminium.

Lengte Length	Breedte Width	Hoogte Height	Art-Nr. Art.-No.
400	720	60	RAMPE-AW-TR301-40
500	720	80	RAMPE-AW-TR301-50
600	720	100	RAMPE-AW-TR301-60



Dørtrinbro aluminium | Threshold bridges made of aluminium.

Lengte Length	Breedte Width	Hoogte Height	Art-Nr. Art.-No.
400	700	30	RAMPE-BT-30-400
900	700	80	RAMPE-BT-80-900





Dit arbejdsmiljø starter her

Vil i spare de tunge løft i hverdagen?

Her er muligheden for at håndtere de tunge plejesenge, og i rigtig mange tilfælde kan denne opgave udføres af blot en person.

En stærk hjælper i hverdagen med 100 % fokus på arbejdsmiljø for den enkelte medarbejder.

Vognen tager det tunge løft og giver en sikker håndtering i arbejdet med flytning af senge.

vognen er designet til at kunne udføre denne opgave på en sikker og nem måde.

Vognen kan opbevare seng, madras og sengegavle på en gang

Sengevognen er fremstillet i stål med Alu-zink overfladebehandling, hvilket giver lang holdbarhed.

Der er påmonteret sikkerhedscertificeret spil med automatisk bremsefunktion, i begge retninger.

Sengevognen overholder kravene fra Sikkerhedsstyrelsen om tekniske hjælpemidler prgf. 612

Vognen er Dansk Produceret og med patenteret design.



Easy Push

Mere komfort ved skub for ledsagere, lynspænder for en enkel brug og fastgørelse på kørestolen, højdejusterbar uden værktøj, inkl. Beslag rør-Ø 22 / 25 mm, leveringsomfang: 1 par. | Additional comfort for wheelchair companions, quick-release levers for an easy usage and fixation on a wheelchair, height adjustable without tools, incl. mounting kit for tube Ø 22 / 25 mm, delivery: 1 pair.

Modeller med Quickrelease |
Models with Quickrelease.

Rør-Ø Pipe Ø	H*	Art-Nr. Art.-No.	HMI Nr
22/25	230	SGE-2	80313
22/25	200	SGE-3	

*Maks. Højdejustering | Max. height adjustment

Modeller med vingeskruer |
Models with wing screws.

Rør-Ø Pipe Ø	H*	Art-Nr. Art.-No.	HMI Nr
22/25	230	SGE-4	
22/25	200	SGE-5	

*Maks. Højdejustering | Max. height adjustment

Skubbehåndtagsforhøjer Push Handle Elevations



Model: SGE-2



Model: SGE-3



Model: SGE-4



Model: SGE-5

Løst beslag | Additional Mounting Piece

Reservedel til SGE-2 / SGE-3, egnet til rør-Ø 22 / 25 mm, leveringsomfang: 1 lynspænder, 2 skruer M6 og 1 rørklemme. | Spare part for SGE-2 / SGE-3 suitable for tube Ø 22 / 25 mm, delivery scope: 1 quick-release lever, 2 screws M6 and 1 tube clamp.

Art-Nr.
Art.-No.

U-BEF-SGE-2-V



Find vores vare på
HMI-basen



Rolko **EasyTRANSFER**

Glidebrætter
Transfer Boards



Letter flytningen af personer, f.eks. fra kørestolen til sengen eller ind i bilen, selvstændig brug uden fremmed hjælp mulig, FÅS i 2 versioner: Standard og buet med antislip. Kan kombineres med vores drejeskive. | Facilitates the transfer of persons e.g. from wheelchair to bed or car, independent usage without external help possible, available in 2 models: standard and curved with anti-slip pads, combinable with our transfer disc.

B	L	H			Art-Nr. Art.-No.	HMI Nr
230	700	12	1,65	130	RBK-700-01	102514
215	670	10	1,25	130	RBK-KV	135488
215	750	10	1,25	130	RBK-KV-2	143315

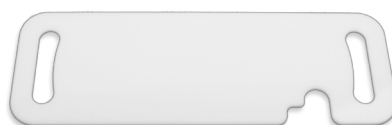

Standard
RBK-700-01



Buet | Curved
RBK-KV / RBK-KV-2



Rolko **EasyTRANSFER**

Forflytningsbælte
Transfer Belts



Forflytningsbæltet muliggøre flytning af en person, eks. fra en kørestol til en seng. Det findes to modeller, hoftebælte og benbælte. begge typer kan bruges i sammenhæng med hinanden og vores andre forflytninge produkter | Facilitate the transfer of persons e.g. from wheelchair to bed, 2 models: hip belt or leg belt, both can be combined with each other and with our other transfer aids.

	B	L			Art-Nr. Art.-No.	HMI Nr
Hoftebælte Hip belt	130	1.200	0,23	130	TFG-L	143316
Benbælte Leg belt	220	1.000	0,23	130	TFH-L	143317

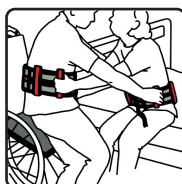

TFG-L



TFH-L

Paraplyer til rollatorer/kørestole | Rollator/Wheelchair Umbrellas

Med HMI Nr.
www.hmi-basen.dk

Paraplyer | Umbrellas

PROTEKTOR giver optimal beskyttelse mod regn og sol, mens rollatoren kan benyttes med begge hænder. Også velegnet til kørestole, med individuel højdeindstilling, praktisk automatisk åbning, vindsikker på grund af konstruktionen med overlappende stof, let at montere og afmontere, inkl. monteringsæt til almindelige rollatorer med rundt rør (Ø 18 - 25 mm) eller ovalt rør på op til 60 mm, skærm diameter: 1.000 mm. | PROTEKTOR offers an optimal protection against rain and sun, while leaving both hands free to push the rollator, also suitable for wheelchairs, height adjustable, user-friendly automatic opening, windproof due to overlapping fabric construction, easy to attach and to remove from the rollator, including mounting kit for common rollators with round tube (Ø 18 - 25 mm) or oval tube up to 60 mm, umbrella diameter: 1.000 mm.

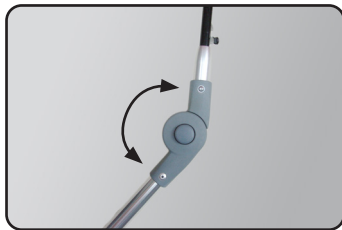

Knækket til flere indstillingsmuligheder |
Articulated joints for many adjustment options

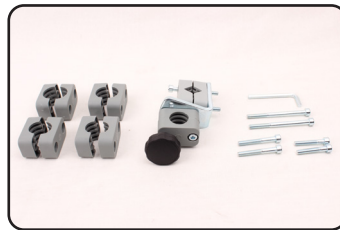

Inkl. fiksering til rundt rør Ø 18-25, ovalt rør på op til 60 mm |
Incl. fixation for round tube Ø 18-25, oval tube up to 60 mm

Til et andet hjælpemiddel, som f.eks. en kørestol, leveringsomfang: 90°-vinkelholder med klemmer (Ø 18 - 25 mm), inkl. kileklemmer, skruer, unbrakonøgle og stjernegreb. | For a second medical aid, e.g. a wheelchair, delivery scope: 90° angle support with clamps (Ø 18 - 25 mm), incl. wedge clamps, screws, Allen wrench and star grip.



HA-SCH-BEF-90

Find vores vare på
HMI-basen



Rolko EasyTRANSFER

Drejeskive
Transfer Disc



Hjælp til forflytning af personer fra kørestolen og til sengen eller til en anden siddeplads. Kan kombineres med vores glidebrætter. | Allows a convenient transfer of persons from the wheelchair to the bed or into another sitting position, the independent use, without helper, is possible, can be combined with our transfer boards.

Ø	H	W	D	Art-Nr. Art.-No.	HMI Nr
410	37	1,7	130	DRT-400	108740

Rolko BAG

Kørestolstaske
Wheelchair Bag



Praktisk selesystem for en nem montering på manuelle og elektriske kørestole. Komfortable holdeløkker på lynlåsene, holdesystem til flasker og gennemgående huller til kabelføring. Vandtæt og smudsafvisende, med intelligent system af opdelt rum. | Practical belt system for easy attachment to manual and electric wheelchairs. Comfortable grip loops on the zippers, holding system for bottles and openings for cable. Waterproof and dirt resistant.

B	H	T	Art-Nr. Art.-No.	HMI Nr
360	470	150	BAG-01-G	76855



Dockingstation til remme
| Docking station for
straps



Sidelomme med kabel-
føring | side pocket with
cable eyelet



Hovedrum med selesystem til
flasker | main bag with straps
for bottles



Tasker til kørestole | Bags for Wheelchairs

Rolko MESSENGER BAG

Messenger-tasker til kørestole Wheelchair Messenger Bags



Til kørestole, også mulig at bruge som skuldertaske. Til at hænge på skubbehåndtaget eller bøjlen på kørestolen/rollatoren. Aftagelig skulderrem, smuds- og vandafvisende, farve: Blågrøn eller grå. Kan leveres med individuelt påtryk fra en købsmængde på 20 stk., f.eks. med dit logo. | For wheelchairs and rollators, may also be used as a shoulder bag. For hanging on the push handle or frame of wheelchairs/rollators. Removable shoulder strap, dirt and water resistant, colour: blue-green or grey. Individually printable, e.g. with your logo (minimum order quantity: 20 pcs.).



Til at hænge på skubbehåndtaget/bøjlen | To hang on the push handles/frame



Rummeligt indvendigt rum | Spacious inner compartment



Lomme med lynlås på bagsiden | Pocket with zipper on the back side



Dæklappen fås med individuelt påtryk | Cover flap individually printable

B	H	T	Art-Nr. Art.-No.	HMI Nr	
●	380	270	110	BAG-02	88715

B	H	T	Art-Nr. Art.-No.	HMI Nr	
○	265	380	120	BAG-03-G	114809

Indkøbsnet | String Bags

Inkl. monteringsløkke og elastik, maks. volumen 11 eller 15,5 liter, maks. bæreevne 20 kg, bredde (løkke/løkke) 55 cm | Incl. fixation loops and elastic band, max. volume 11 or 15.5 litres, max. load 20 kg, width (loop/loop) 55 cm

Art-Nr. Art.-No.	HMI Nr	
NETZ-1-S	80471	
NETZ-1-S-B	M. Inderpose	80472



NETZ-1-S
15,5 liter | Litres



NETZ-1-S-B
11 liter | Litres

Rolko Thermo

Kørepose til børn Body Warmer for Kids



Vores køreposer til børn består af fnugfri invendig polar-fleeceforing og vandafvisende ydermateriale, hvorfor de er ideelle til koldt og regnfuldt vejr. Velegnet til selesystemer på almindelige kørestole til børn samt rehauggies: Klip køreposerne ind i de påsyede strimler. Lynlås med gribeløkker hele vejen rundt. Rygsele til fastgørelse på kørestolen/buggyen. Kan vaskes ved op til 30°C. | Our children body warmers are made from a non-lint polar fleece liner and a water-repellant outer material, being optimal for cold and rainy weather. Suitable for belt systems of common wheelchairs and strollers: simply cut into the stitched strips. Circumferential zipper with handle loops. Back strap for the attachment on the wheelchair/stroller. Washable up to 30°C.

Størrelse Size	Alder Age	Kropsstørrelse Body size	Art-Nr. Art.-No.	HMI Nr
XXS	1-3 år years	800-980*	WW-KID-1-DK	110876
XS	4-8 år years	1000-1280*	WW-KID-2-DK	110873



Med refleksstriber |
With reflective stripes



Loop til nem lukning af lynlås |
Hoop for easy zipping

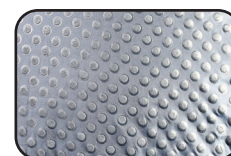

Skridsikker underside |
Non-slip bottom

Rolko Thermo

Thermo køreslag Thermo Leg Protection



Vores thermo køreslag giver en optimal beskyttelse mod fugt og kulde til benene, på grund af det vandafvisende yderstof. Nem håndtering: Læg posen over benene uden hjælp udefra og anbring fødderne i fodsektionen med elastik. Nem at fastgøre ved hjælp af bånd med trykknapper. Kan vaskes ved op til 30°C. | Due to the water-repellant outer material our leg protection offers an optimal protection for the legs during wet and cold conditions. Easy to use, without outside help: put the leg protection over your legs and align the feet in the feet area with elastic band. Easy attachment with straps with push buttons. Washable up to 30°C.

Størrelse Size	L	Art-Nr. Art.-No.	HMI Nr
L	1150	WWA-L	108739



Nem montering på kørestolen |
Easy fixation on wheelchair



Refleksstriber for mere sikkerhed |
Reflective stripe for more safety



Inderstof af Polar-fleece |
Polar fleece inner lining

Thermo køreposer til kørestolsbrugere | Thermo Wear for Wheelchair Users

Rolko Thermo Køreposer til Voksne Body Warmer for adults



Vores køreposer består af et vandafvisende ydermateriale og er ideelle til koldt og regnfuldt vejr. Den fnugfri indvendige foring af Polar-fleece sørger for en behagelig varme. Komfortabel at håndtere på grund af lynlåsen med store grebeløkker hele vejen rundt. Kan vaskes ved op til 30°C. | Our body warmers are made from a water-repellant outer material, being perfect for cold and rainy weather. The non-lint polar fleece liner provides a pleasant warmth comfort. Easy to use due to circumferential zipper with large handle loops. Washable up to 30°C.



Størrelse Size	Kropsstørrelse Body size	Art.-Nr. Art.-No.	HMI Nr
S	op til/up to 1600*	WW-S-DK	85475
M	op til/up to 1700*	WW-M-DK	108851
L	op til/up to 1800*	WW-L-DK	76850
XXL	op til/up to 1950*	WW-XXL-DK	76857

*Anbefalet kropsstørrelse i millimeter | Recommended body size in millimeters



Forlomme med refleksstriber | Front pocket with reflective stripe



Fikseringsløkker til skubbehåndtag | Fixation loops for push handles



Skridsikker underside | Non-slip bottom

Med HMI Nr. www.hmi-basen.dk

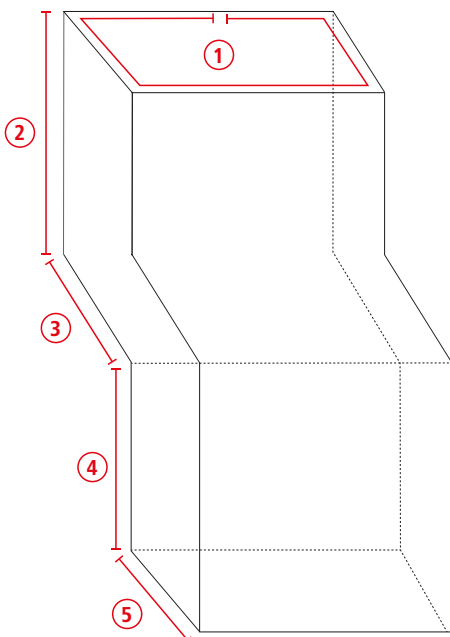

Kørepose-størrelser | Body Warmer Dimensions (Artikelnr. | Item no.)

	Voksne Adults				Børn Children	
	WW-S	WW-M	WW-L	WW-XXL	WW-KID-1	WW-KID-2
①	1300	1420	1590	1850	850	1050
②	410	440	470	500	260	300
③	430	460	490	510	280	340
④	400	425	470	500	270	380
⑤	300	315	320	350	180	220

Mål i millimeter | Dimensions in millimeters

Rolko rainPRO

Regntøj til kørestole Wheelchair Rainwear



Regnslaget Rolko-rainPRO sørger for den optimale beskyttelse mod vind og vejr med sit vandtætte yderstof og den indvendige foring af bomuld. Nem at tage på: Lynlåsen kan betjenes både inde- og udefra. Inkl. Refleksstriber foran og bagpå, samt hætte og inderlomme. | With a waterproof outer material and a cotton inner lining, the rain poncho Rolko-rainPRO provides an ideal weather protection. Easy to use: the double-sided zipper can be operated from inside and outside. Incl. reflective stripes on the back and front side, hood and inside pocket.

Størrelse Size	L1*	L2*	Art-Nr. Art.-No.	HMI Nr
Universal	1000	650	WRP-L	85473

*L1: Længde fortil, L2: Længde bagpå | *L1: Front length, L2: Rear length



Udsparinger til skubbe-håndtag | Push handles cutouts



Lynlås med refleksstriber
| Zipper with reflective stripes



Indvendig foring af bomuld | Cotton inner lining



Køreslag Rolko-rainPRO byder på en optimal beskyttelse mod våde ben med det vandtætte yderstof. Nem håndtering: Læg ganske enkelt køreslag over benene uden hjælp udefra og anbring fødderne i fodsektionen med gummitræk. Nem at fastgøre ved hjælp af bånd med trykknapper. Inkl. refleksstriber. | Due to the waterproof outer material the leg protection Rolko-rainPRO offers an optimal protection for the legs during wet conditions. Easy to use, without outside help: just put the leg protection over your legs and align your feet in the feet area with elastic band. Easy attachment with straps with push buttons. Incl. reflective stripe.

Størrelse Size	L	Art-Nr. Art.-No.	HMI Nr
Universal	1150	WRA-L	85472



Elastisk bånd for mere bærekomfort | Elastic band: comfortable to wear



Refleksstriber for mere sikkerhed | Reflective stripe for more safety



Indvendig foring af bomuld | Cotton inner lining

Rolko rainPRO ACTIVE

Regntøj til kørestole Wheelchair Rainwear



Regnslaget Rolko-rainPRO råder over et vandtæt yderstof samt et let inderstof med netstruktur. Den praktiske lynlås kan betjenes både inde- og udefra. Inkl. hætte, inderlomme, refleksstriber fortil og bagpå samt ærmer for mere bevægelsesfrihed. | The rain cape Rolko-rainPRO has a waterproof outer material and a light inner material with mesh structure. Handy double-sided zipper may be used from inside and outside. Incl. hood, inner pocket, reflective stripes on the back and front side as well as sleeves for more freedom of movement.

	Størrelse Size	L1*	L2*	Art-Nr. Art.-No.	HMI Nr
Uden fodsektion No foot area	Universal	1000	650	WRC-L	100203
Med fodsektion With foot area	Universal	1500	540	WRB-L	102512

L1: Front length, L2: Rear length



Udsparinger til skubbe-håndtag | Push handles cutouts



Lynlås med refleksstriber | Zipper with reflective stripe



Med eller uden fodsektion | With or without foot area



Rollator-regnslaget Rolko-rainPRO sørger med sit vandafvisende yderstof for beskyttelse mod vind og vejr til rollatorbrugere og almindelige rollatorer. Nem at tage på: Lynlåsen kan betjenes både inde- og udefra. Inkl. refleksstriber foran og bagpå samt hætte. | With a waterproof outer material the rollator rain poncho Rolko-rainPRO provides best weather protection for rollator users and common rollators. Easy to use: the double-sided zipper can be operated from inside and outside. Incl. reflective stripes on the back and front side and hood.

Størrelse Size	L1*	L2*	Art-Nr. Art.-No.	HMI Nr
Universal	1200	1100	WRP-R-L	127405

*L1: Længde fortil, L2: Længde bagpå | L1: Front length, L2: Rear length



Passer til almindelige rollatorer | Ideal for common rollators



Lynlås med refleksstriber | Zipper with reflective stripe



Rolko rainPRO

Kørestolsgarage Wheelchair Cover



Garage til almindelige kørestole: Vandtæt, UV- og frostbestandig. Den ideelle beskyttelse mod vind og vejr samt støv. Løkker i farver til opbevaring og orientering: rød bagpå, sort fortil. Snoretræk og vægtbånd for en optimal fiksering. De gennemgående refleksstriber til afmærkning af den langsgående retning gør den nem at håndtere. | Our cover for common wheelchairs: water-proof, UV and frost resistant. Ideal against weather and dust. Coloured loops for an easy storage and orientation: red on the back, black on the front. Drawstrings and weight bands ensure an optimal fixation. A continuous reflective stripe points in the longitudinal direction, simplifying the handling.



L	H	B	Art-Nr. Art.-No.	HMI Nr
1050	900	700	WRS-M	114344



Også egnet til små elektriske kørestole | Also suitable for small power wheelchairs



Snoretræk for et sikkert hold | Drawstrings for a safe hold



Løkker til opbevaring/ orientering | Loops for storing and as an orientation

Rolko rainPRO

Rollatorgarage Rollator Cover



Rollatorgaragen Rolko-rainPRO beskytter rollatorer mod smuds, støv samt vind og vejr: Vandtæt, UV- og frostbestandig. Velegnet til almindelige rollatorer. Inkl. vægtbånd for et godt hold. Refleksstriber afmærker den langsgående retning og gør det nemmere at håndtere den. | The rollator cover Rolko-rainPRO protects rollators against dirt, dust and weather: water-proof, UV and frost resistant. Ideal for common rollators. Incl. weight tape for a firm hold. A reflective stripe points in the longitudinal direction, simplifying handling.



L	H	B	Art-Nr. Art.-No.	HMI Nr
800	800	630	WRR-L	102513



Refleksstriber afmærker den langsgående retning | Reflective stripe indicates longitudinal direction



Skueglas til mærkning af rollatoren | Window to label the rollator



Opbevaring/håndtering ved hjælp af løkker | With loops: easy to use and store

Overtræksgarage til Elscootere | Covers for Rehabilitation Devices

Rolko
rainPRO

Scootergarage Scooter Cover



Vores scooter-garager består af et vandtæt, UV- og frostbestandigt materiale. Den ideelle beskyttelse mod vind og vejr samt støv. Refleksstriberne afmærker den langsgående retning og gør det dermed lettere at håndtere den. Inkl. vægtbånd og løkker. Kan leveres i XL og XXL (egnet til almindelige rehabiliteringscykler). | Our scooter covers are made from a water-proof, UV and freeze resistant material. Ideal against weather and dust. A reflective stripe points in the longitudinal direction, simplifying handling. Incl. weight bar and loops. Available in XL and XXL (suitable for common therapy bicycles).



Størrelse Size	L	H	B	Art-Nr. Art.-No.	HMI Nr
S	1050	950	600	WRG-S-K	105564
XL	1450	1100	700	WRG-XL	85474
XXL	1550	1100	700	WRG-XXL	114802



Refleksstriber afmærker den langsgående retning | Reflective stripe indicates longitudinal direction



Opbevaring ved hjælp af løkker | With loops: easy to use and store

Rolko
rainPRO

Sædeovertræk til scooter Scooter Seat Cover



Vores sædeovertræk til scootersæder består af et vandtæt, UV- og frostbestandigt materiale. Den ideelle beskyttelse mod vind og vejr samt støv. Med velcrobånd og elastik en enkel montering på scooteren. Hovedstøtten tildækkes også. Universalstørrelse til almindelige scootere. | Our scooter seat cover is made from a water-proof, UV and freeze resistant material. Ideal against weather and dust. With hook and loop straps and elastic band for an easy attachment on scooters, covering also the head rest. Universal size for common scooters.

L	B	Art-Nr. Art.-No.	HMI Nr
1500	900	WRH-M	114355



Velcrobånd til montering | Hook and loop straps for fixation



Universalstørrelse | Universal size



Rolko rainPRO

Køreslag til scootere Scooter Leg Protection



På grund af det vandtætte ydermateriale og den fnugfrie indvendige foring af Polar-fleece giver køreslaget til scootere Rolko-rainPRO den ideelle beskyttelse til benene i koldt og vådt vejr. Enkel enhåndsbetjening: Læg køreslaget over benene og fastgør hofteselen med den praktiske magnetlås. Inkl. forlomme. | Due to the waterproof outer material and the non-lint polar fleece liner the scooter leg protection Rolko-rainPRO provides optimal covering of the legs during cold and wet conditions. Easy one-handed operation: just put the leg protection over the legs and easily fasten the belt with the handy magnetic lock. Incl. front pocket.

B	H	Art-Nr. Art.-No.	HMI Nr
1000	1000	WRA-Scooter-M	110907



Enhåndsbetjening med magnetlås |
One-hand use with magnetic belt



Varm, quiltet Polar-fleece | Warm polar fleece, quilt lining



Praktisk forlomme |
Practical front bag



Rolko Thermo

Køretæppe Wrap-up Blankets



Køretæppet Rolko-Thermo er til vinter og efterår, da det består af et vandafvisende ydermateriale og en quiltet og fnugfri inderforing af Polar-fleece. Køretæppet sørger dermed for, at du holder dig tør og behageligt varm. Nemt at håndtere med velcrolukninger. Kan vaskes ved op til 30°C. | With a water-repellant outer material and a quilted, lint-free polar fleece lining, the Wrap-up Blanket Rolko-Thermo is the perfect companion in autumn and winter ensuring that you stay dry and comfortably warm. Easy to use due to hook and loop fasteners. Washable up to 30°C.

Størrelse Size	B	H	Art-Nr. Art.-No.	HMI Nr
L	1450	1150	WB-L	85476
XXL	1800	1250	WB-XXL	85477



Vandafvisende ydermateriale |
Water-repellent material



Varm, quiltet Polar-fleece | Warm polar fleece, quilt lining



Nemt at håndtere med velcrolukninger |
With hook & loop straps

Rolko AIRpad

Luftsiddepuder
Air Seat Cushions

Med HMI Nr.
www.hmi-basen.dk



Anti-liggesår op til Klasse II |
Anti-decubitus up to grade II



Puder af viskoelastisk skum med luftkammer og ventil til individuel regulering af luftmængden. Op til Klasse II, ifølge EPUAP (European Pressure Ulcer Advisory Panel), optimal fordeling af brugerens vægt med ergonomisk formgivning af puden, maks. bæreevne: 150 kg.
| Cushion made of a visco-elastic foam with air chamber and valve for an individual regulation of the air volume, suitable for decubitus prophylaxis and therapy up to grade II, according to EPUAP (European Pressure Ulcer Advisory Panel), great weight distribution due to ergonomic shape of the cushion, max. load: 150 kg.

Luftpude med standardbetræk | Air cushions with standard cover

B	T	H	Art-Nr. Art.-No.	HMI Nr
380	400	80	SK-AIR-380x400x80-S	77438
400	400	80	SK-AIR-400x400x80-S	77439
430	400	80	SK-AIR-430x400x80-S	77447
430	430	80	SK-AIR-430x430x80-S	86201
450	400	80	SK-AIR-450x400x80-S	77446
450	450	80	SK-AIR-450x450x80-S	77448
480	430	80	SK-AIR-480x430x80-S	77449

*Hjælpeidnummeret gælder kun for luftpudderne med standardbetræk.



Luftkammer med ventil til regulering uden pumpe | Air chamber with valve, adjustment without pump



Vaskbart betræk med lynlås | Washable Cover with zipper



Brandhæmmende ifølge DIN EN 1021-1 + 2 | Flame retardant according to DIN EN 1021-1 + 2



Inkontinensbetræk | Incontinence cover

Separate Inkontinensbetræk til Rolko-AIRpad, vandtæt | Incontinence covers for Rolko-AIRpad, waterproof

B	T	H	Art-Nr. Art.-No.	HMI Nr
380	400	80	SK-COVER-380x400x80-I-S	77450
400	400	80	SK-COVER-400x400x80-I-S	77451
430	400	80	SK-COVER-430x400x80-I-S	77452
430	430	80	SK-COVER-430x430x80-I-S	88545
450	400	80	SK-COVER-450x400x80-I-S	77454
450	450	80	SK-COVER-450x450x80-I-S	77453
480	430	80	SK-COVER-480x430x80-I-S	77455

Standardpuder | Seat Cushions

Vores standardpude findes i 16 størrelser og passer både til kørestole og elscootere. Puden er betrukket med 4-vejs strækbart Decutex inkontinensbetræk. Betrækket har lynlås på undersiden for at undgå væske indtrængen, samt en anti-slip overflade og er vaskbart på 40°.

Puden er lavet med en skrå forkant for at give mest mulig komfort, til brugeren. Den har en hårdhed på 30 +/- 5 shore.

Max brugervægt 100kg, kolli størrelse 13 stk.

Our standard seat cushion has 16 different sizes and fits both wheelchair and electric scooters. The cushion has a 4-ways stretchable, Decutex incontinens cover. The zip on the cover is places on the underside, to avoid liquids to pass, further more the backside is cover with an anti-slip surface and is washable at 40°.

The cushion had a slanted front angle to improve and comforn. The density of the cushion is 30 +/- 5 shore.

Max user weight 100kg, Coli size 13 pcs.

B	T	H	Art-Nr. Art.-No.	HMI Nr
280	300	50	SK-DK-280x300x50	80481
300	300	50	SK-DK-300x300x50	131545
320	320	50	SK-DK-320x320x50	80488
350	350	50	SK-DK-350x350x50	80482
380	400	50	SK-DK-380x400x50	80473
400	400	50	SK-DK-400x400x50	80476
400	430	50	SK-DK-400x430x50	80471
400	450	50	SK-DK-400x450x50	80479
425	400	50	SK-DK-425x400x50	80475
425	425	50	SK-DK-425x425x50	80478
425	450	50	SK-DK-425x450x50	80474
450	400	50	SK-DK-450x400x50	80483
450	450	50	SK-DK-450x450x50	80484
450	500	50	SK-DK-450x500x50	80485
500	450	50	SK-DK-500x450x50	80486
500	500	50	SK-DK-500x500x50	80487

Med HMI Nr.
www.hmi-basen.dk

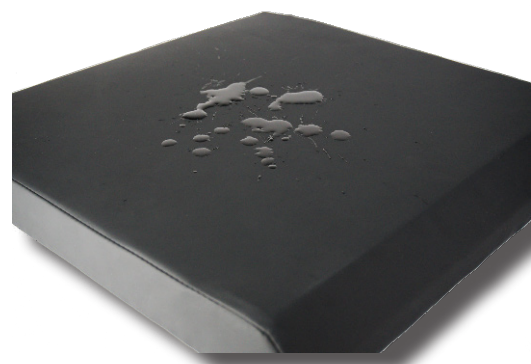

Rolko kørestolspude med 4-vejs strækbart, inkontinens betræk.



Pude med ekstra sikkerhed i form af anti-slip bund

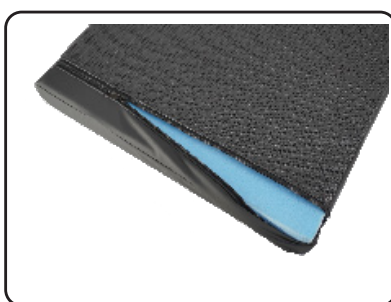

Lyslås på bagsiden gør den nemt og hurtigt at skifte betræk.

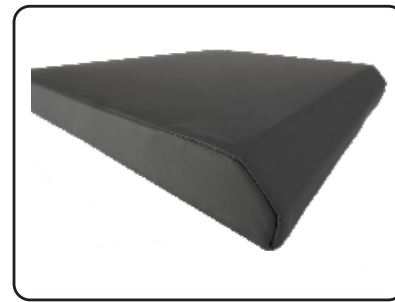

Betræk med 4-vejs stræk og stærk holdbarhed. Skrå forkant, for at give en bedre komfort.

Ekstra betræk kan købes separat.

Scooter-tilbehør | Scooter Accessories

Rollatorholder til standard-rollatorer, montering ved hjælp af firkantholder 25x25 mm, halvskåle med velcrobånd | Rollator holder for standard rollators, fixation with square socket 25x25 mm, half shells with hook-and-loop straps

B	T	H	Art-Nr. Art.-No.	HMI Nr
400 - 570	220	424-560	ROH-SC2-DK	86801



Sidevejs forskydelig



Rollatorholder til rollatorer, der foldes i siden, montering med firkantholder 25x25 mm, forbedret tilpasningsmulighed, inkl. velcrobånd |

Rollator holder for side-foldable rollators, fixation with square socket 25x25 mm, better adaptability, incl. hook-and-loop strap

B	T	H	Art-Nr. Art.-No.	HMI Nr
186	220	424-560	ROH-SC4	86804

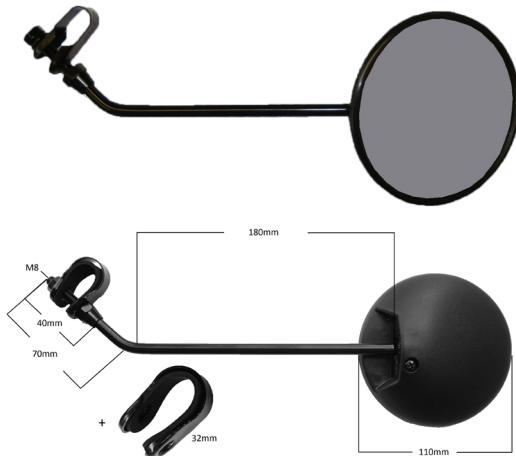

Universal-bakspejl til scootere. Med klemme og sekskantskrue M8 til montering, leveres i par á 2 stk | Universal scooter rear mirror with clamp and hexagon bolt M8 for fixation, delivery scope: 1 pc.

Art-Nr. Art.-No.
SP-60029002

Stokkeholder med firkantrør 25x25 mm, skål med sidevægge til 2 stokke, inkl. velcrobånd | Cane holder with square tube 25x25 mm, bowl with sidewalls for 2 canes, incl. hook-and-loop strap

B	T	H	Art-Nr. Art.-No.	HMI Nr
300	232	706	STH-SC1	76854

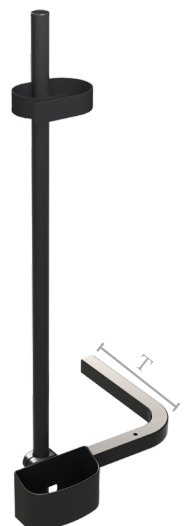

Bagagebox med lås

L	H	B	Art-Nr. Art.-No.	HMI Nr
400 mm	300 mm	370 mm	25 L Box 25	114812



Lækker bagageboks med en volume på 25L. Boksen er med lås som gør, at du kan efterlade dine ting sikkert. Dejlig stor og tydelig refleks der yder en ekstra sikkerhed. Boksen kan også monteres på en cykel.

På www.RolkoShop.dk finder du vores produkter.

Har du endnu ikke adgang, kan du få et login via hjemmesiden.

Du er også velkommet til at kontakte os på Info@rolko.dk og tlf: 8720 1888

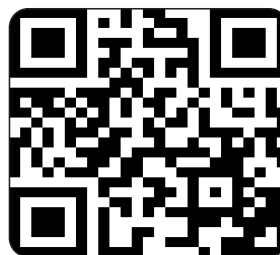

STOKKEHOLDER

Art-Nr. Art.-No.	HMI Nr
STH-SC5	114812

Til montering på 4-kant rør 25x25. Fremstillet i sort KTL belagt stål.



Scooter-tilbehør | Scooter Accessories

Monteringsbeslag

Art-Nr.
Art.-No.

BAH-SC1

Monteringsbeslaget kombineret med forlængere stykket giver en mulighed for en næsten universal montage af bagageboks, kurven & stokkeholderen på EL-scooteren

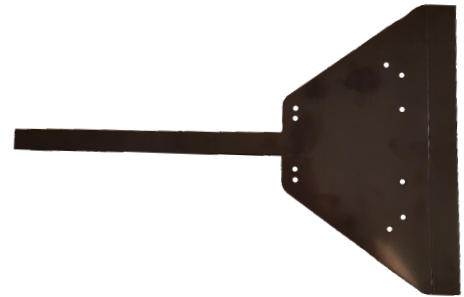

Iltflaske holder

Art-Nr.
Art.-No.

Flh-SC1

Flaskeholder i VA / Stål, KTL belagt sort, justerbar for flasker af varierende størrelser

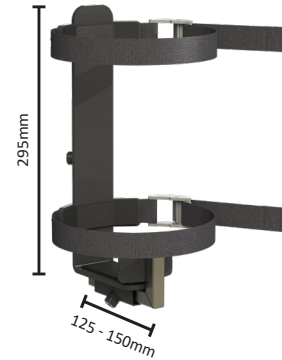

Forlænger Stykke

Art-Nr.
Art.-No.

U-EXT-30-150

U-EXT-30-170

Forlænger stykke til monteringsbeslag for mere fleksibelt montage



Kurve

L

H

B

Art-Nr.
Art.-No.

400 mm

290 mm

180 mm

KURV-1

400 mm

290 mm

180 mm

KURV-2

220 mm

380 mm

420 mm

SC-HK1

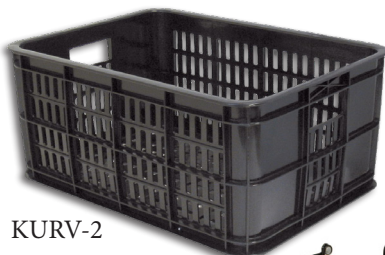

REGNSLAG

Art-Nr.
Art.-No.

WR-KURV

Regnslag til bagkurv og plastkasse
Vandafvisende polyester materiale





Til 1 stok, inkl. selebånd og Rørbeslag | For 1
cane, incl. strap and fixation clamp

	Art-Nr. Art.-No.	HMI Nr
22	STH1-22-GB	80431
25	STH1-25-GB	80433



Til 2 stokke, inkl. selebånd og Rørbeslag |
For 2 cane, incl. strap and fixation clamp

	Art-Nr. Art.-No.	HMI Nr
22	STH2-22-GBSO	80450
25	STH2-25-GBSO	80452



Til 2 stokke, inkl. selebånd og Rørbeslag |
For 2 cane, incl. strap and fixation clamp

	Art-Nr. Art.-No.	HMI Nr
22	STH2-22-GB	80445
25	STH2-25-GB	80447



Til 2 stokke, inkl. selebånd og Rørbeslag |
For 2 cane, incl. strap and fixation clamp

	Art-Nr. Art.-No.	HMI Nr
22	STH4-22-GB	80455
25	STH4-25-GB	80457



Rørbeslag inkl. skrue | Fixation clamp
incl. screw

	Art-Nr. Art.-No.
22	U-SCH22-STH-CN
25	U-SCH25-STH

Stokkeholdere | Cane Holders

	Art-Nr. Art.-No.	HMI Nr
22	STH2-22-CL-GB	80462

Til 2 stokke, inkl. selebånd og låseclips | For 2 cane, incl. strap and fixation clamp



25	STH2-25-CL-GB	80463
----	---------------	-------

	Art-Nr. Art.-No.	HMI Nr
22	STH4-22-CL-GB	80465

Til 2 stokke, inkl. selebånd og låseclips | For 2 cane, incl. strap and fixation clamp



25	STH4-25-CL-GB	80466
----	---------------	-------

	Art-Nr. Art.-No.	HMI Nr
25	STH3-25-KL	81084

Til 1 stok, inkl. låseclip | For 1 cane, incl. fixation clip



Klemme til 1 stok, inkl. låseclip | Clamp for 1 cane, incl. fixation clip

	Art-Nr. Art.-No.	HMI Nr
22	KL-STH-CL22	80468
25	KL-STH-CL25	80469

Låseclip | Fixation clip

	Art-Nr. Art.-No.
22	U-Clip-22
25	U-Clip-25

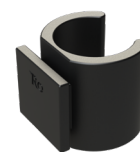



Til 2 stokke, inkl. Selebånd og universal-låseklemme |
For 2 canes, incl. strap and universal fixation clamp

	Art-Nr. Art.-No.
22-25	STH2-22/25-GB



Til 2 stokke, inkl. Selebånd og universal-låseklemme |
For 2 canes, incl. strap and universal fixation clamp

	Art-Nr. Art.-No.	HMI Nr
22-25	STH4-22/25-GB	87317



Klemme til 1 stok, med 28mm rørbeslag
| Clamp for 1 cane, with 28mm tube clamp

Art-Nr. Art.-No.
KL-STH-P#-28



Klemme til 1 stok, inkl. universal-låseklemme | Clamp for 1 cane, incl. universal fixation clamp

	Art-Nr. Art.-No.
22-25	KL-STH-22/25



Universal-låseklemme til rør-Ø 22-25 mm, inkl. 2 skruer M5x20 | Universal fixation clamp for tube Ø 22-25 mm, incl. 2 screws M5x20

	Art-Nr. Art.-No.
22-25	SCHK-22/25-STH

Hofte-/skuldreseler | Hip and Shoulder Belts

2-punkt, let metallås |
2-point, light metal buckle

L	B	Art-Nr. Art.-No.	HMI Nr
1800	40	SHG-GB40S-KS	78889

2-punkt, metallås | 2-point, metal buckle

1800	50	SHG-GB50S-KS-D	78890
2250	50	SHG-GB50S-2400	78891
1500	50	SHG-GB50S-SCHL	78893
1350	50	SHG-GB50S-Öse	78894
1800	50	SHG-GB50-S-4xKS	

2-punkt, snaplås af plast |
2-point, snap buckle made of plastic

L	B	Art-Nr. Art.-No.	HMI Nr
1600	40	SHG-KS-GB40-KS	78896



L	B	Art-Nr. Art.-No.
1800	50	SHG-GB50S-OESE-120-10-01
2250	50	SHG-GB50S-OESE-150-10-01
1500	50	SHG-GB50S-OESE-180-10-01

Omløbende, metallås |
Circumferential, metal buckle

L	B	Art-Nr. Art.-No.	HMI Nr
2000	50	SHG-GB50S-F	78895

Selefiksering |
Belt fixation



CE



CE



CE



CE



CE



Hofte-/skulderseler | Hip and Shoulder Belts

CE



4-punkt Y-Sele med hoftepuder, maks. længdeindstilling på låsen: 80 mm, uden selefiksering | 4-point with hip pads, length adjustment on the buckle: max. 80 mm, without belt fixation

Størrelse
Size

Art-Nr.
Art.-No.

HMI
Nr

S

SHG-4P-GB25S-PO

85488



Selefiksering |
Belt fixation

CE



4-punkt Y-Sele med hoftepuder, længdeindstilling på låsen: maks. 100 mm | 4-point with hip pads, length adjustment on the buckle: max. 100 mm

Størrelse
Size

Art-Nr.
Art.-No.

HMI
Nr

L

SHG-4P-GB40S-PO

80295

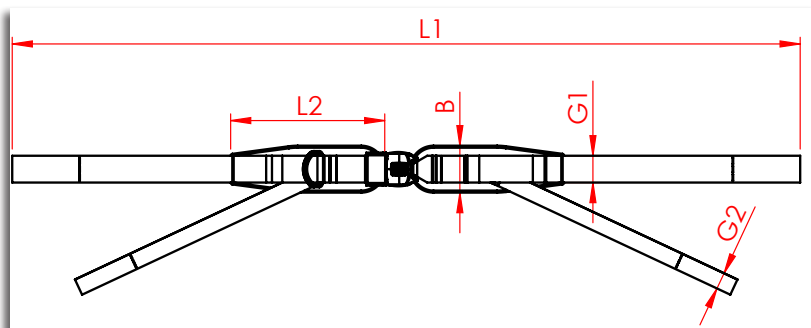

	L1	L2	B	G1	G2
S	1400	190	50	25	20
L	1800	230	70	40	25

Hofte-/skuldreseler | Hip and Shoulder Belts

4-punkt, 3 spænder, 2 lynjusteringer, længde på hoftese: op til 1.850 mm, længde på buksesele: op til 900 mm |
 4-point, 3 triglides, 2 quick adjusters, lap belt length: max. 1,850 mm, suspender belts length: max. 900 mm.

B	Art-Nr. Art.-No.	HMI Nr
40	SHG-4P-GB40S-KS-D	80296



Selefiksering |
Belt fixation



Lynjustering |
Quick adjustment



Med HMI Nr.
www.hmi-basen.dk

5-punkt, 4 spænder, 2 lynjusteringer, længde på de diagonale seler: Hver maks. 1.850 mm, længde på skridtsele: maks. 500 mm. | 5-point, 4 triglides, 2 quick adjusters, length of the diagonal belts: each max. 1,850 mm, crotch belt length: max. 500 mm.

B	Art-Nr. Art.-No.	HMI Nr
25/40	SHG-3/5P-GB40SV	80297



Selefiksering |
Belt fixation



Lynjustering |
Quick adjustment



Seler med stiftsikring | Hip and Shoulder Belts



2-punkt, lås med stiftsikring, der kun kan oplåses med en spids genstand | 2-point, buckle with security-pin actuation, unlockable only with a pointed object

L	B	Art-Nr. Art.-No.	HMI Nr
1800	50	SHG-SI-GB50S-KS	82221



Selefiksering |
Belt fixation



B	Art-Nr. Art.-No.	HMI Nr
40/25	SHG-SI-4P-GB40S-PO	125536

4-punkt med lynjusteringer og gennemgående hoftesele, lås med stiftsikring, der kun kan oplåses med en spids genstand | 4-point with quick adjustment and lap belt, buckle with security-pin actuation, unlockable only with a pointed object

B	Art-Nr. Art.-No.	HMI Nr
40	SHG-SI-4P-GB40S-KS	82222



Selefiksering |
Belt fixation

Lægbånd | Calf Straps

Med velcrolukning | With hook and loop tape

	L	B	SB	Art-Nr. Art.-No.
Standard	700	50	340-430	WG-700-KB
StandardS	820	50	440-530	WG-820-KB
Glat Smooth	850	80	440-530	WG-850S-KB



Standard



Glat | Smooth

Hælbånd Heel Straps

FG-250-KB: 2-delt, hver med en løkke (Ø 13 mm) og en velcrolukning. FG-450-KB: 1-delt med en løkke (Ø 13 mm) og en løkke med velcrolukning, farve: Sort |
FG-250-KB: 2-piece, each with one loop (Ø 13 mm) and one hook and loop tape. FG-450-KB: 1-piece with one loop and one hook and loop tape, colour: black.

L	B	Art-Nr. Art.-No.
240-430	50	FG-250-KB
450	50	FG-450-KB

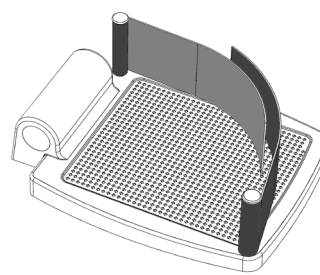

FG-250-KB

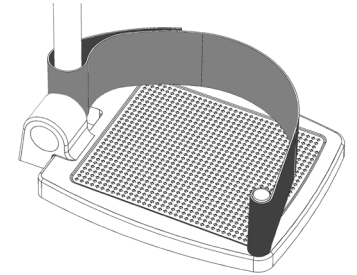

FG-450-KB

Antivip-hjul | Anti-tip Wheel

Antivip-hjul med adapter til rørdiameter 22 + 25 mm, en vandret og en lodret boring |
Anti-tip wheel with adapter for tube diameter 22 + 25 mm, one horizontal and one vertical bore

	Art-Nr. Art.-No.	HMI Nr
22+25	KSH-22/25-02	86482

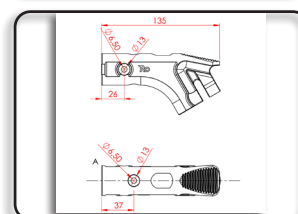
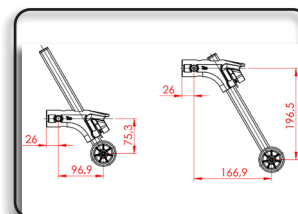

Bremsegreb med Parkeringslås

Håndbremser af plast | Hand brakes made of plastic



		Art.-Nr. Art.-No.
--	---	----------------------

Selvlåsende Self-locking	22	HB-F-MK
Manuel Manual	22	HB-F-MK-MR

Selvlåsende Self-locking	20	HB-F-RK80-SR20
Selvlåsende Self-locking	21	HB-F-RK80-SR21
Selvlåsende Self-locking	22	HB-F-RK80SR22
Selvlåsende Self-locking	25	HB-F-RK80SR25
Manuel Manual	22	HB-F-RK80MR22
Manuel Manual	25	HB-F-RK80MR25

Selvlåsende Self-locking	22	HB-F-RK36SR22
Selvlåsende Self-locking	25	HB-F-RK36SR25
Manuel Manual	22	HB-F-RK36MR22
Manuel Manual	25	HB-F-RK36MR25

Enhåndsbetjent multikredsløbs-bremse af aluminium til 2 wire |
One-hand multi-circuit brake made of aluminium for 2 bowden cables

	22	HB-F-EMB
--	----	----------

Udløsergreb af plast | Release levers made of plastic

	22	AH-K-22
	25	AH-K-25

Bremsegreb til Rollator

Bremse til rollator, Plastik, bremse og parkerings funktion, til rør ø 22 mm |
Brake for walkers, brake and parking function, for tubes ø 22 mm

		Art.-Nr. Art.-No.
--	--	----------------------

	22	HB-F-ROL-SL-22
--	----	----------------

Rolko Product management

Vi er drevet af innovation og at tage dine ideer fra papir til virkelighed.

Hos Rolko Scandinavia arbejder vi konstant på at imødekomme din produkt udvikling, og følger din rejse lige fra den første ide til serie produktion og derfra rafineringen af dit produkt.

Vi sikre at kvaliteten lever op til netop dine ønsker, bla. via en omfattende kvalitetskontrol.

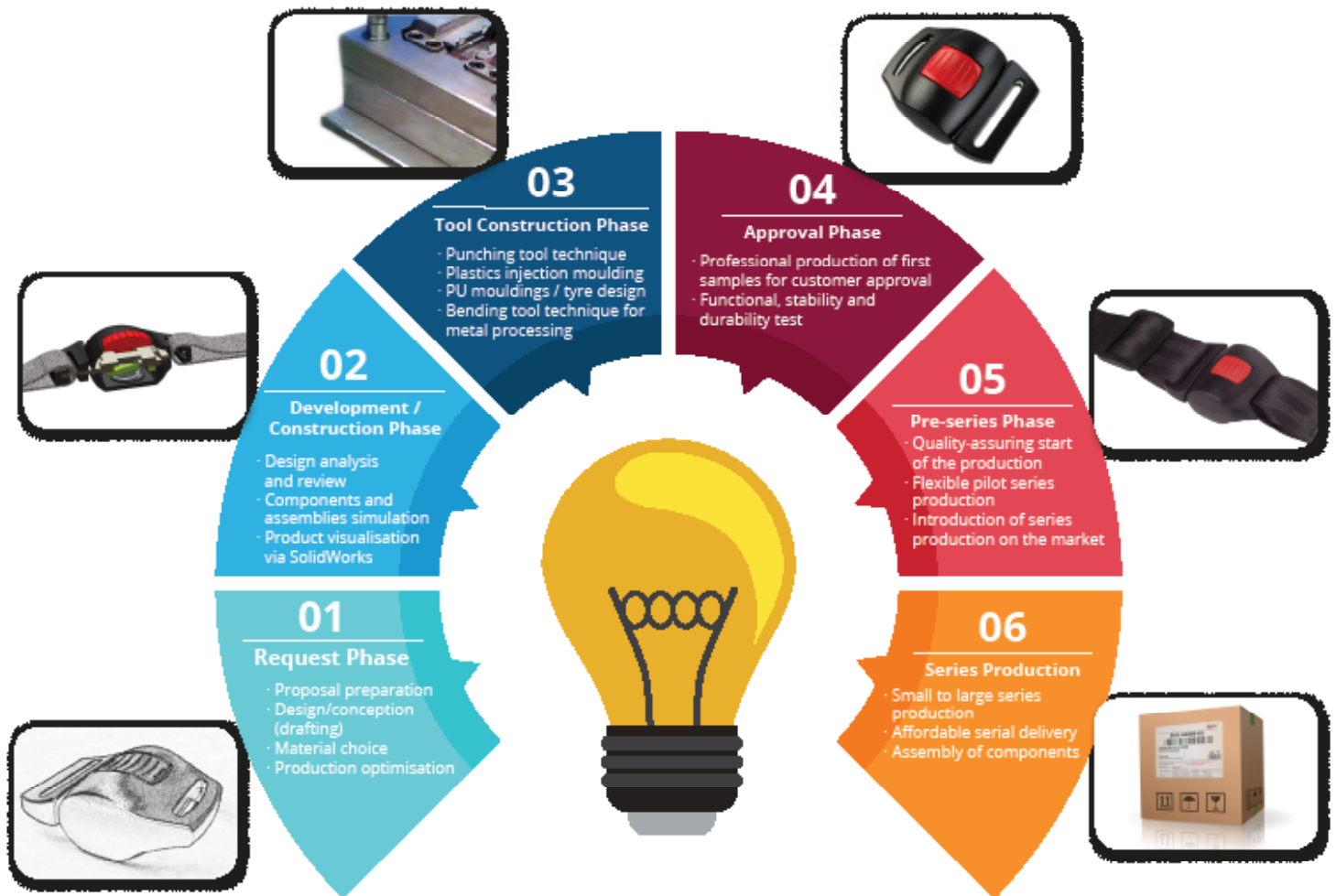

Vores kompetencer - Din succes

Vi har mange kompetencer inden for produktion af netop dit emne. Her får du blot et lille udsnit.

- Fremstilling af støbeforme til både plast og alu
- 3D print
- Polyurethan og gummi støbning
- Produktion af dæk med infill
- CNC bearbejdning
- Laser skæring
- Svejsning af Stål, rustfrit stål og Aluminium
- Overflade behandling som; pulver lake-ring, anodisering, galvanisering
- Tekstil produktion, Syning, og Ultra sonisk svejsning af tekstil

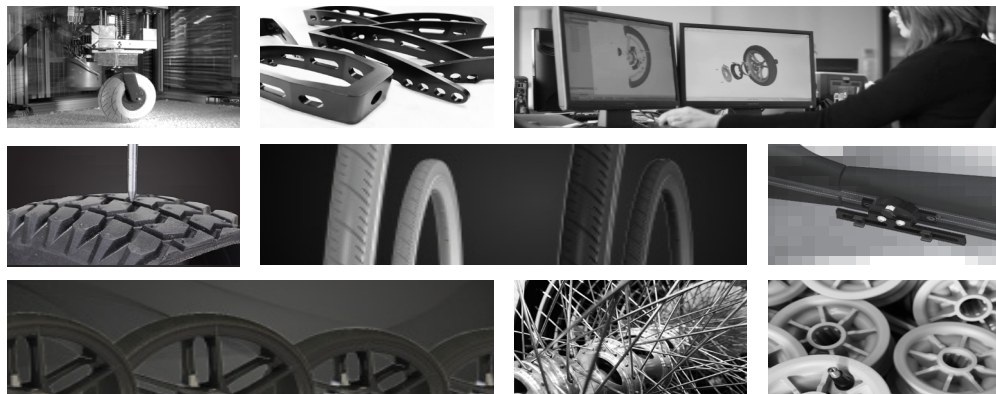

Bremser og tilbehør | Brakes and Accessories

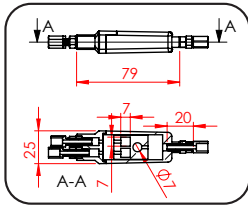
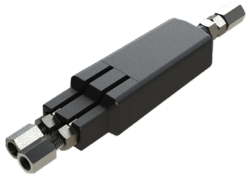

Kabelfordeler med 3 justerskruer til wire med tønne 6x7 mm | Bowden cable switch with 3 adjustment screws for bowden cables with barrel 6x7 mm

Art-Nr.
Art.-No.

BZW-E

Klemmeskrue til Bowdentræk |
Clamp screw for Bowden cables

Art-Nr.
Art.-No.

U-BZ-1250

*Minimum bestillingsmængde 25 stk. | MOQ: 25 pcs.

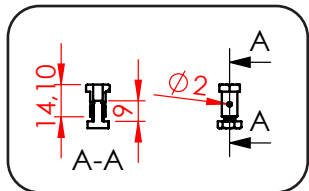

Låseskrue til Bowdentræk |
Fixing screw for Bowden cables

Art-Nr.
Art.-No.

U-BA-BZ-F-SM5

*Minimum bestillingsmængde 10 stk. | MOQ: 10 pcs.

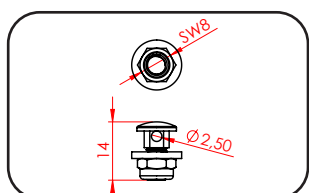

Ø 6,20 mm

Ø 2,20 mm

Kabelføring til Bowdentræk |
Bowden cable guide

Art-Nr.
Art.-No.

90° vinkel | 90° angle

F-BZ-90

Fleksibel | Flexible

F-BZ-FLEX



Ø 6,20 mm

Ø 2,20 mm

Endenippel til både inder og yderkabler. Praktisk plastbøtte med henholdsvis 500 og 200 stk | Cable ends for both inner and outer cable. packed 500 / 200 pcs in practical container.



Art-Nr.
Art.-No.

Til yderkabel | For outer

U-EN-CT2800-B

Til wirer | For inner

U-EN-CT2700-B

Klemmeskrue til Bowdentræk |
Clamp screw for Bowden cables

Art-Nr.
Art.-No.

U-BZ-KLS-6.5-7

Ø7 x 6,5 mm

U-BZ-MINI

Ø8 x 15 mm

U-BZ-1180

Ø6 x 9 mm



Stilleskrue til Bowdentræk |
Adjusting screws for Bowden cables

Art-Nr.
Art.-No.

U-BA-BZ-E-SM5

U-BA-BZ-E-BRLQM-E

*Minimum bestillingsmængde 20 stk. | MOQ: 20 pcs.

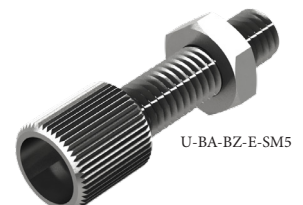
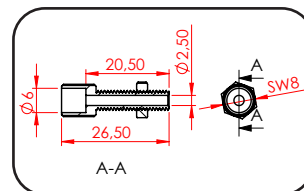

U-BA-BZ-E-SM5

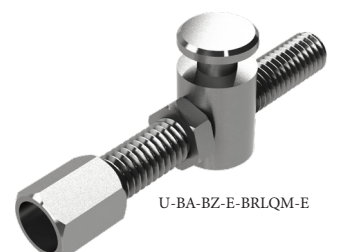
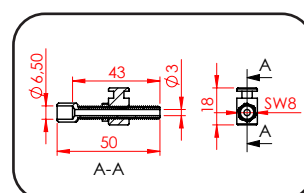

U-BA-BZ-E-BRLQM-E

Bremser og tilbehør | Brakes and Accessories

Komplet kabel til Solero Kørestole. Længde 1345/1240 mm, Rustfri wire Ø1,5mm, tødenipple Ø5 mm. Komplet med endehylster til den originale bremse og 70° vinklet justeringskrue | Preassembled cable for Solero wheelchair. Length 1345/1240 mm. Complete with original fittings and 70° bend and adjustment.

L	Art-Nr. Art.-No.
1345/1240	BZ-MR-1345/1240-VA-KPL

Komplet kabel til Futura Rollator. Ø1,5 mm rustfri inderkabel med kuglenipple. Sort ø6 mm yderkabel med 2 endehylser | Preassembled cable for Futura walker. Ø1,5 stainless steel wire with ball ends. 6mm outer cable with fitting ends.

720/630	BZ-FR-720/630-VA
---------	------------------

Komplet kabel til Troja Rollator. Rustfri wire med specifik endeni-
nippler. Messing forniklet justeringskrue m6 x 30 |
Preassembled cable for Troja walker. Stainless steel wire with Troja
specific ends. Nickelbrass adjustment screw m6 x 30

1195/1055	BZ-TR-1195/1055-KPL
-----------	---------------------

Kabelrulle med 50m. Spiral snoet bremsekabel, sort, Ø4,9 mm med
hvid PE indersok. | Cable drum with 50 m, Sprial brake cable. Black,
Ø4.9 mm, with white PE inner.

50 m	BZ-H-BREMSE
------	-------------

Kabelrulle med 50m. Push-Pull for øget stivhed, sort, Ø4,9 mm med
hvid PE indersok. | Cable drum with 50 m, Push-Pull for increased
strength. Black, Ø4.9 mm, with white PE inner.

50 m	BZ-H-PP
------	---------

Kabel klipper. Perfekt til afkortning af både yder- og inderkabler. |
Cable cutter. Perfekt for shortning Wires and outercables.

BZ-KK

Bremsewire i rustfrit stål 1,5 mm, uden muffe, tønne 7x6 mm eller
pære 10x5x3 mm, levering i kartondispenser. | Stainless steel Bowden
cables 1,5 mm, without sheath, barrel 7x6 mm or bulb 10x5x3 mm,
delivery in cardboard dispenser.

L	Art-Nr. Art.-No.
Pære Bulb 10x5x3 mm	2000 BZ-D-2000-VA-P-BOX
Tønne Barrel 7x6 mm	2000 BZ-D-2000-VA-T-BOX
Kugle Ball ø 8 mm	2000 BZ-D-2000-VA-K-BOX

*Minimum bestillingsmængde 100 stk. | MOQ: 100 pcs.

Til Solero Kørestole



Til Futura Rollator

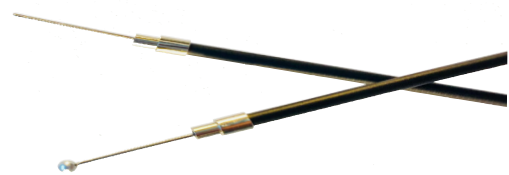

Til Troja / Leopard / Gemino Rollator

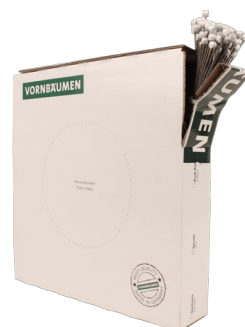

Model | Model:
BZ-HB-B-OH



Model | Model:
BZ-HB-T-OH

Håndtag og rørovertræk | Hand Grips and Tube Covers



Standard-håndtag af plast, leveringsomfang: Par |
Standard hand grip made of plastic, delivery scope: pair

L		Art-Nr. Art.-No.
110	22	GR-KS



Komfort-håndtag af plast, leveringsomfang: Par |
Comfort hand grip made of plastic, delivery scope: pair

L		Art-Nr. Art.-No.
120	22	GR-ERGO-S
120	25	GR-ERGO-S-25



Ergonomisk håndtag med blød grebsflade, leveringsomfang: Par |
Ergonomic hand grip with soft grip surface, delivery scope: pair

L		Art-Nr. Art.-No.
120	22	GR-ERGO-GS



Ergonomisk håndtag af plast, leveringsomfang: Par |
Ergonomic hand grip made of plastic, delivery scope: pair

L		Art-Nr. Art.-No.
125	22	GR-S



Håndtag af blød skumgummi, leveringsomfang: Par |
Hand grip made of soft foam rubber, delivery scope: pair

L		Art-Nr. Art.-No.
120	22	GR-120
150	22	GR-150

Håndtag og rørovertræk | Hand Grips and Tube Covers

Rørovertræk af blød skumgummi, ru | Tube cover, soft foam rubber, rough

L		Art-Nr. Art.-No.
210	22	GR-210
260	22	GR-260
680	22	GR-680
260	24	GR-260-BO24/7
680	24	GR-680-BO24/7

Rørovertræk af blød skumgummi, glat | Tube cover, soft foam rubber, smooth

210	22	GR-210-G
260	22	GR-260-G
680	22	GR-680-G

Rørovertræk af plast, glat, mat, biokompatibelt |
Tube cover, plastic, smooth, mat, biocompatible

370	19	GR-370-18/19
1250	19	GR-1250-18/19

Fikseringsspray til håndtag Fix4Grip, 50 ml | Hand grip fixation spray Fix4Grip, 50 ml

Art-Nr. Art.-No.
F4G



På www.RolkoShop.dk finder du vores produkter.
Har du endnu ikke adgang, kan du få et login via hjemmesiden.

Du er også velkommet til at kontakte os på Info@rolko.dk og tlf: 8720 1888



Egerbeskyttere | Spoke Guards

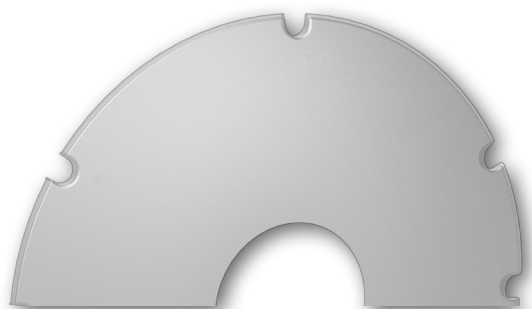

Inkl. 4 låseclips | Incl. 4 fixation clips

Tykkelse: 1 mm, transparent, udsparinger til drivringe, levering: 1 stk. | Thickness: 1 mm, transparent, notches for push rims, delivery scope: 1 pc.

Størrelse Size			Udsparing Notches	Art-Nr. Art.-No.
20"	432	136	4	SP-TR-510L4
22"	470	140	4/6	SP-TR-570L4/6
24"	513	140	4/6	SP-TR-620L4/6
26"	566	140	4/6	SP-TR-670L4/6
28"	600	142	6/12	SP-TR-720L6/12



Inkl. 6 låseclips | Incl. 6 fixation clips

Tykkelse: 1,5 mm, transparent, udsparinger til drivringe, 6 dobbeltslidser til variabel montering på egerne, levering: 1 stk. | Thickness: 1,5 mm, transparent, notches for push rims, 6 double slits for variable fixation on the spokes, delivery scope: 1 pc.

24"	512	150	4/6	SP-TR-620-1-DS
-----	-----	-----	-----	----------------

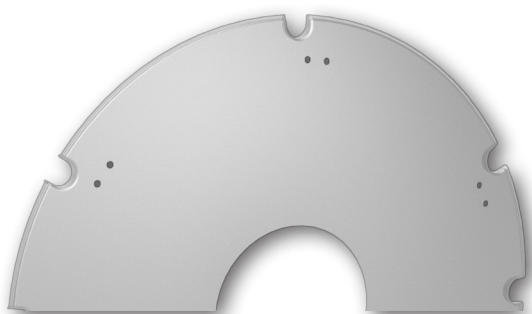

Tykkelse: 1,5 mm, transparent, udsparinger til drivringe, 6 dobbelthuller til kabelbindere, levering: 1 stk. | Thickness: 1,5 mm, transparent, notches for push rims, 6 double bores for cable ties, delivery scope: 1 pc.

24"	512	150	4/6	SP-TR-620-1
-----	-----	-----	-----	-------------

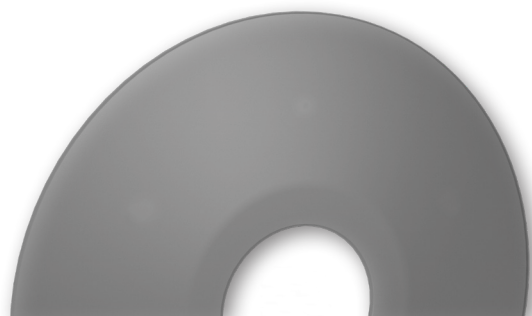

Inkl. 4 låseclips | Incl. 4 fixation clips

Tykkelse: 1 mm, transparent, uden udsparinger til drivringe og monteringshuller, levering: 1 stk. | Thickness: 1 mm, transparent, without notches for push rims and fixation bores, delivery scope: 1 pc.

22"	445	136	-	SP-TR-570
24"	485	140	-	SP-TR-620

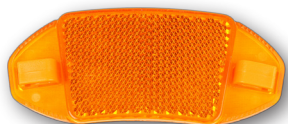

REF1

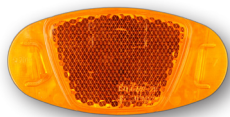

REF2

Egerreflekser | Spoke reflectors

B	H	Art-Nr. Art.-No.
90	40	REF1
75	35	REF2

Fodskål og -remme | Foot Rests and Belts

Fodplade til rørdiameter 22 mm |
Foot board for tube diameter 22 mm

L	B	Art-Nr. Art.-No.
173	140	FB-K-173-S



Fodstøtter med langhuller og skruehuller, leveringsomfang:
Par | Foot rests with slots and thread-holes, set with 2 pc.

L	B	B1	Størrelse Size	Art-Nr. Art.-No.
175	87	69	34	FS-K-180
209	103	73	35	FS-K-215
236	115	89	37	FS-K-240
286	141	108	45	FS-K-280
329	158	125	50	FS-K-320

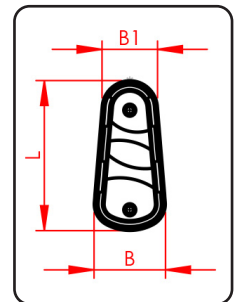

Rem med velcrobånd til fodstøtter, leveringsomfang:
4 remme |
Hook and loop strap for foot rests, delivery scope: 4 straps

L	B	Art-Nr. Art.-No.
700	38	FG-FS-700

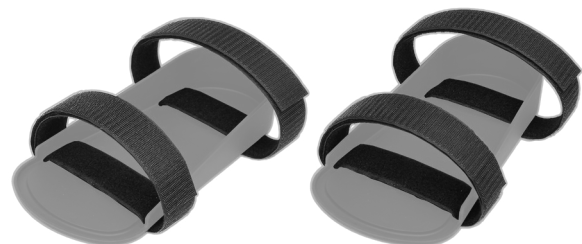

Fodremme, leveringsomfang: Par | Ankle belts, set with 2 pcs.

Størrelse Size	Art-Nr. Art.-No.	HMI Nr
Medium	FG-M	80300
Large	FG-L	80301



Inkl. monteringsæt
|
Incl. fixation kit

Af plast, transparent | Made from plastic, transparent

B	T	H	Art-Nr. Art.-No.
392	255	25	TAB-01

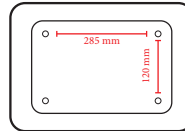

Afstand mellem stifter |
Pin distance



Rollator-rygsele | Rollator Back Strap

Stabil og polstret, til almindelige rollatorer med runde rør på 22 mm, nem at montere med rørklemmer. |
Stable and padded, for common rollators with round tube 22 mm, easy assembly with tube clamps.

	L	B	Art-Nr. Art.-No.
22	575-640	65	RG-ROL-01



Alle tekniske informationer er med forbehold.

Illustrationer er ikke bindende.
Med forbehold for ændringer.

Vi leverer i henhold til vores seneste
generelle slags- og leveringsbetingelser.

Alle billeder, tekster og grafik i det aktuelle
Rolko katalog er beskyttet af copyright.
Enhver brug er underlagt vores samtykke.
Forbehold for fejl og produktændringer.



Få adgang til vores B2B Webshop!

Vi har en B2B webshop, hvor du kan, når det passer ind i din tidsplan, bestille varer! Vi opdatere shoppen løbende, så du altid har adgang til nyheder og anden brugbar produkt information.

www.RolkoShop.dk



Tilmeld dig nyhedsbrevet!

Ved at tilmelde dig vores nyhedsbrev, er du først til at få adgang til nyheder og gode tilbud fra Rolko. Tilmeld dig via info@rolko.dk



softMOTION



Terta drivring med integreret soft-indlæg, skånsom at bruge for hænderne, det bedste greb, indlægget lukker åbningen mellem drivring og fælg og beskytter fingrene, ideel f.eks. til rehabilitering af børn, til almindelige boks-fælg. | Push rim with integrated soft insert, hand-friendly use, best grip, the insert closes the gap between push rim and rim protecting the fingers, ideal for children's rehab, for common box rims.

Størrelse Size			L	Art-Nr. Art.-No.
22"	500	473*	6 30	GF22K-TE-6LS-473FS
24"	552	524*	6 30	GF24K-TE-6LS-524FS

Laskeafstand | Space between links

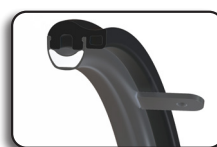

Integreret indlæg for det bedste greb | Integrated insert for the best grip

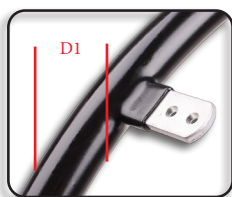

Drivring af aluminium, ekstra blødt betræk til bedre greb. | Push rim made of aluminium, extra-soft coating for the more grip.

22"	490	472*	4 20	GF22-AS-SOFT
24"	545	523*	6 20	GF24-SOFT-6-DK
26"	590	563*	6 20	GF26-AS-SOFT
24"	545	523	4 20	GF24-SOFT-4-DK

Laskeafstand | Space between links



Aluminiums drivring, sølv elox. Fire gevindbøsninger M5 | Aluminum push rim, Silver Elox. .Four M5 bushings

20"	446	417	4 19,6	GF20-ALU-4M5
22"	483	453	4 19,6	GF22-ALU-4M5
24"	534	513	4 19,6	GF24-Alu-4M5



Softgrebdrivring. Aluminiums drivring belagt med sort PVC. Fire gevindbøsninger M5 | PVC coated pushrim, Four M5 Bushings
Push rim made of stainless steel.

20"	446	428	4 20	GF20-SOFT-4M5-DK
22"	483	453	4 20	GF22-SOFT-4M5-DK
24"	534	513	4 20	GF24-SOFT-4M5-DK

Monteringsæt: 6 skruer M5x10 mm og 6 sekskantsmøtrikker M5. | Fixation kit: 6 pan head screws M5x10 mm and 6 hexagon nuts M5.



Art-Nr.
Art.-No.

U-BEF-GR-6-L

Drivringe og tilbehør | Push Rims and Accessories

Drivringsovertræk af silikone, ekstra blødt, rillet |
Comfortable push rim covers made of silicone, supersoft, grooved

Størrelse Size		T	Art-Nr. Art.-No.
20"	412-424	16-21	SGR-20
22"	486-501	16-21	SGR-22
24"	519-532	16-21	SGR-24
26"	571-590	16-21	SGR-26

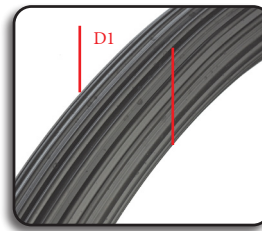

Drivringsovertræk af silikone, ekstra blødt, glat |
Comfortable push rim covers made of silicone, supersoft, smooth

Størrelse Size		T	Art-Nr. Art.-No.
20"	412-424	16-21	SGR-20-G
22"	486-501	16-21	SGR-22-G
24"	519-532	16-21	SGR-24-G
26"	571-590	16-21	SGR-26-G

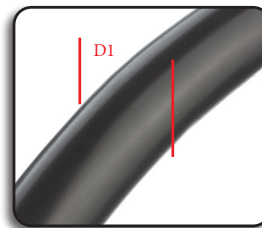

Hjulafdækning | Wheel Mud Guards

Af plast, universal | In plastic, universal

Størrelse Size	L	H	B	Art-Nr. Art.-No.
24"	460	100	50	RA460/48-S
24"	645	270	40	RA620/35-S1

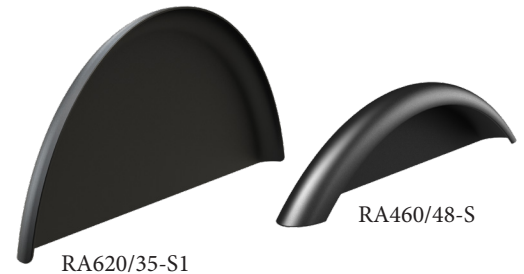
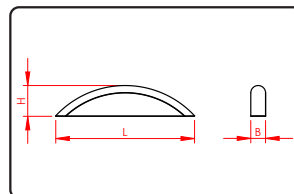

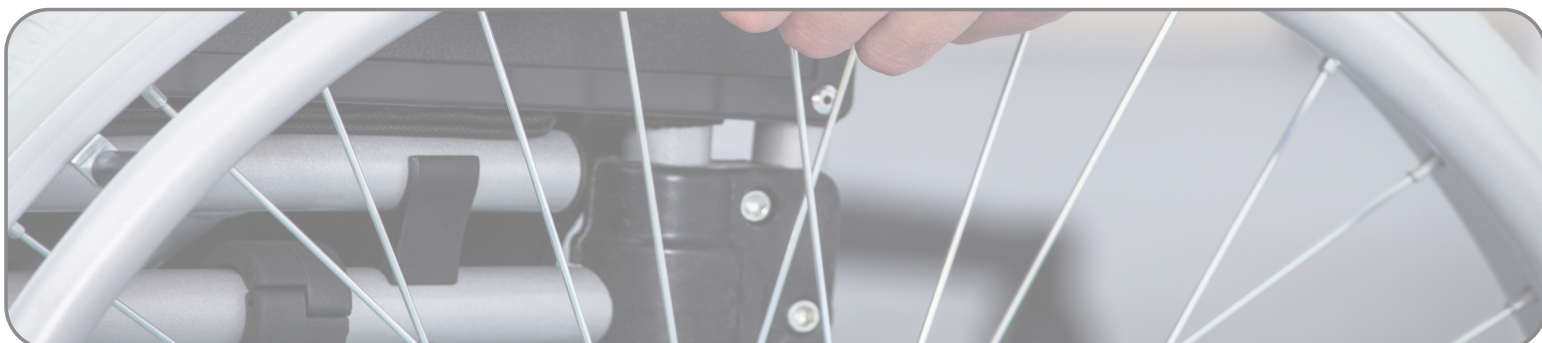
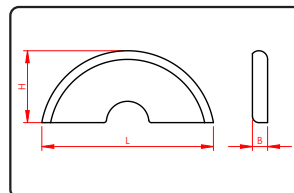

20"	545	220	59	RA510/35-S
22"	590	243	57	RA570/35-S
24"	645	270	57	RA620/35-S



Purbane Drivhjul | PU tire Spoke Wheels



Aluminiumfælg og -drivring med 4 monterings huller. Purbane dæk, 1.1/3# med i blok mønster og 1" med sildebens mønster. | Aluminium rim and push rim with 4 fixations, PUR tire, Allround for 1.1/3" and PUR tires in Classis for 1"



	Størrelse Size				Art-Nr. Art.-No.	Kolli
Grå Polyurethan dæk	20x1.1/3"	53	63	12 mm	R510/35-PUBA-GFA-DZ	8
Grå Polyurethan dæk	22x1.1/3"	53	63	12 mm	R570/35-PUBA-GFA-DZ	8
Grå Polyurethan dæk	24x1.1/3"	53	63	12 mm	R620/35-PUBA-GFA-DZ	8
Grå Polyurethan dæk	22x1"	53	63	12 mm	R570/25-PUBA-GFA-DZ	8
Grå Polyurethan dæk	24x1"	53	63	12 mm	R620/25-PUBA-GFA-DZ	8





Aluminiumfælg og -drivring med 4 monterings huller. Sort purbane dæk, 1.1/3# med i blok mønster og 1" med sildebens mønster. | Aluminium rim and push rim with 4 fixations, PUR tire, Allround for 1.1/3" and PUR tires in Classis for 1"

	Størrelse Size				Art-Nr. Art.-No.
Polyurethan Dæk Sort	20x1"	53	63	12 mm	R510/35-PUSA-GFA-R401
Polyurethan Dæk Sort	22x1"	53	63	12 mm	R570/35-PUSA-GFA-R401
Polyurethan Dæk Sort	24x1	53	63	12 mm	R620/35-PUSA-GFA-R401



Smart Standard Drivhjul | Smart Spoke Wheels



Aluminiumfælg og -drivring med 4 monterings huller. Luftdæk med 2-komponent Smart fyldning. Komplet punkteringsfri | Aluminium rim and push rim with 4 fixations, Air tire with 2-component Smart fill. Complete puncture free wheel

	Størrelse Size				Art-Nr. Art.-No.
RolkoSmart	20x1"	53	63	12 mm	R510/25-GFA-DZ-SMART-S
RolkoSmart	22x1"	53	63	12 mm	R570/25-GFA-DZ-SMART-S
RolkoSmart	24x1"	53	63	12 mm	R620/25-GFA-DZ-SMART-S

Standard Drivhjul | Spoke Wheels

Smart Standard Drivhjul | Smart Spoke Wheels



Aluminiumfælg og -drivring med 4 monterings huller. Luftdæk med 2-komponent Smart fyldning. Komplet punkteringsfri | Aluminium rim and push rim with 4 fixations, Air tire with 2-component Smart fill. Complete puncture free wheel

	Størrelse Size				Art-Nr. Art.-No.
RolkoSmart	20x1"	53	63	12 mm	R510/25-DK-RS12
RolkoSmart	22x1"	53	63	12 mm	R570/25-DK-RS12
RolkoSmart	24x1"	53	63	12 mm	R620/25-DK-RS12



Luft Standard Drivhjul | Air Spoke Wheels





Aluminiumfælg og -drivring med 4 monterings huller. Monteret med grå dæk og slange | Aluminium rim and push rim with 4 fixations. With gray tire and tube

	Størrelse Size				Art-Nr. Art.-No.
Luft dæk m. slange	20x1"	53	64	12 mm	R510/25-LA-GFA
Luft dæk m. slange	22x1"	53	64	12 mm	R570/25-LA-GFA
Luft dæk m. slange	24x1	53	64	12 mm	R620/25-LA-GFA



Off-Road Drivhjul | Outdoor Spoke Wheels

Aluminiumfælg og -drivring med 6 lasker, luftdæk med Mountain Bike-profil Schwalbe „Land Cruiser“. | Aluminium rim and push rim with 6 links, pneumatic tyre with mountain bike tread Schwalbe „Land Cruiser“.





	Størrelse Size					Art-Nr. Art.-No.
Venstre Left	24x1.90"	53	63	12 mm	75	R620/50-LA-GFA-L
Højre Right	24x1.90"	53	63	12 mm	75	R620/50-LA-GFA-R
Venstre Left	24x1.90"	53	63	1/2"	75	R620/50-LA-GFA-L-1/2
Højre Right	24x1.90"	53	63	1/2"	75	R620/50-LA-GFA-R-1/2



Punkteringsfrie Svindhjul | Puncture free wheels





Plastfælg med med gummibane | Plastic rim with solid rubber tyre



						Art-Nr. Art.-No.
100	24	25	8	22	R100/24-5-VS	
125	24	25	8	25	R125/24-5-VS	





Plastfælg med polyurethan-dæk | Plastic rim with polyurethane tyre



						Art-Nr. Art.-No.
170	45	46	8	40	R180/45-3-PUSS45	
170	45	60	8	40	R180/45-3-PUSS60	
200	50	60	8	50	R200/50-3-PUSS-SK-01	





Plastfælg med med gummibane | Plastic rim with solid rubber tyre



						Art-Nr. Art.-No.
100	32	36	8	30	R100/32-2-VS-P	
100	32	46	8	30	R100/32-2-VS-P46	
125	32	36	8	35	R125/32-2-VS-P	
125	32	46	8	35	R125/32-2-VS-P46	
150	33	36	8	40	R150/33-2-VS-8/36	
150	33	46	8	40	R150/33-2-VS-8/46	

Plastfælg med med gummibane | Plastic rim with solid rubber tyre



						Art-Nr. Art.-No.
125	40	46	8	35	R125/40-1-VS-46	
125	40	60	8	35	R125/40-1-VS	
140	40	46	8	40	R140/40-1-VS-46	
140	40	60	8	40	R140/40-1-VS	

Alt efter gulvets materiale/farve samt bremseeffekten kan sorte helgummidæk i sjældne tilfælde efterlade misfarvninger. Følg brugsanvisningen fra producenten af gulvet. | Depending on the floor material and colour as well as braking effect, black solid rubber tyres may rarely leave marks in the flooring. Note the instructions for use from the flooring manufacturer.

Design-hjul | Design Wheels

Let aluminiumsfælg med polyurethan bane |
Light aluminium rim with polyurethan tire

						Art-Nr. Art.-No.
100	24	24	8	0,165	28	R100/24-VS-ASI2-25
100	32	36	8	0,210	30	R100/32-VS-ASI2-36
100	32	46	8	0,215	30	R100/32-VS-ASI2-46
125	24	24	8	0,220	32	R125/24-VS-ASI2-25
125	32	36	8	0,275	35	R125/32-VS-ASI2-36
125	32	46	8	0,280	35	R125/32-VS-ASI2-46



Let aluminiumsfælg med polyurethan bane |
Light aluminium rim with polyurethan tire

						Art-Nr. Art.-No.
100	32	36	8	0,260	30	R100/32-VS-ASI-36
100	32	46	8	0,285	30	R100/32-VS-ASI-46
125	32	36	8	0,340	35	R125/32-VS-ASI-36
125	32	46	8	0,352	35	R125/32-VS-ASI-46



Let aluminiumsfælg med polyurethan bane |
Light aluminium rim with polyurethan tire

						Art-Nr. Art.-No.
100	24	25	8	0,244	22	R100/24-VAS
125	24	25	8	0,322	25	R125/24-VAS



Let aluminiumsfælg med polyurethan bane |
Light aluminium rim with polyurethan tire

						Art-Nr. Art.-No.
100	24	25	8	0,244	22	R100/24-VASS
125	24	25	8	0,322	25	R125/24-VASS







Alt efter gulvets materiale/farve samt bremseeffekten kan sorte helgummidæk i sjældne tilfælde efterlade misfarvninger. Følg brugsanvisningen fra producenten af gulvet. | Depending on the floor material and colour as well as braking effect, black solid rubber tyres may rarely leave marks in the flooring. Note the instructions for use from the flooring manufacturer.



Rengøringsvenlige hjul | Easy-to-clean Wheels

Rengøringsvenlige hjul, med helstøbt plast fælg, med afsmitningsfri polyurethan bane. leveres uden islagsbøsninger | Easy-to-clean wheels with fully cast rim from plastic. With Non-marking polyurethane tire. Delivered without bushings.



Størrelse Size					Art-Nr. Art.-No.
4"	100	30	10	6000-2RS	RR100/30-H3-PUSSHD-10
5"	125	30	10	6000-2RS	R125/30-H3-PUSSHD-10
6"	150	32	10	6000-2RS	R150/32-H3-PUSSHD-10
6.5"	165	35	10	6000-2RS	R165/35-H3-PUSSHD-10
7"	178	35	10	6000-2RS	R175/35-H3-PUSSHD-10
8"	200	42	10	6000-2RS	R200/42-H3-PUS-SK

Islagsbøsninger - Fra Ø10 eller Ø12 kuglelejer. Til Ø6 eller Ø8 mm aksel

				Art-Nr. Art.-No.
	Ø10	ø6	2.0 mm krave	U-RB-10-6-2
	Ø10	ø6	6.5 mm krave	U-RB-10-6-6.5
Etac	Ø10	ø6	9mm krave	U-rb-10-6-9
Etac	Ø10	ø6	14.25 mm krave	U-RB-10-6-14.25
	Ø10	ø8	2.0 mm krave	U-RB-10-8-2
	Ø10	ø8	3.0 mm krave	U-RB-10-8-3
	Ø10	ø8	4.0 mm krave	U-RB-10-8-4
	Ø10	ø8	6.5 mm krave	U-RB-10-8-6.5
	Ø10	ø8	14.25 mm krave	U-RB-10-8-14.25
U/Rulletering	Ø10	ø8	2.0 mm krave	U-RBDK-10-8-2
U/Rulletering	Ø10	ø8	4.0 mm krave	U-RBDK-10-8-4
U/Rulletering	Ø10	ø8	6.5 mm krave	U-RBDK-10-8-6.5
U/Rulletering	Ø10	ø8	10 mm krav	U-RBDK-10-8-10
U/Rulletering Etac	Ø10	ø6	9 mm krav	U-RBDK-10-6-9
U/Rulletering Etac	Ø10	ø6	14.25 mm krav	U-RBDK-10-6-14.25
	Ø12	ø8	2.5 mm krave	U-RB-12-8-2.5
	Ø12	ø8	4.0 mm krave	U-RB-12-8-4
Islagsbøsning Ø12	Ø12	ø8	5.5 mm krave	U-RB-12-8-5.5
	Ø12	ø8	7.0 mm krave	U-RB-12-8-7
	Ø12	ø8	9.5 mm krave	U-RB-12-8-9.5
	Ø12	ø8	10.5 mm krave	U-RB-12-8-10.5

Design-hjul: Carbon Line | Design Wheels: Carbon Line

Ultralet karbonfælg med gevindskærm, højglansbeklædning og polyurethan-dæk | Ultralight carbon rim with thread guard, high-gloss coating and polyurethane tyre

						Art-Nr. Art.-No.
75	30	36	8	0,120	23	R75/30-C-TPU-S-F36
75	30	40	8	0,120	23	R75/30-C-TPU-S-F40
75	30	46	8	0,120	23	R75/30-C-TPU-S-F46
100	30	36	8	0,160	28	R100/30-C-TPU-S-F36
100	30	40	8	0,160	28	R100/30-C-TPU-S-F40
100	30	46	8	0,160	28	R100/30-C-TPU-S-F46
125	30	36	8	0,210	30	R125/30-C-TPU-S-F36
125	30	40	8	0,210	30	R125/30-C-TPU-S-F40
125	30	46	8	0,210	30	R125/30-C-TPU-S-F46
150	30	36	8	0,290	34	R150/30-C-TPU-S-F36
150	30	40	8	0,290	34	R150/30-C-TPU-S-F40
150	30	46	8	0,290	34	R150/30-C-TPU-S-F46



Skater hjul | Skater wheels

Plastfælg og polyurethan-dæk | Plastic rim and polyurethane tyre

						Art-Nr. Art.-No.
50	21	21	8	○	15	R50-1TS85-2RS
50	21	24	8	●	15	R50-1SS85-2RS
63	18	20	8	●	20	R63-1SS85-2RS
64	24	25	8	○	20	R64-1TS85-2RS
72	24	25	8	●	23	R72-1SS85-2RS
72	24	25	8	○	23	R72-1TS78-2RS
76	24	24	8	○	24	R76-1TS85-2RS
76	24	24	8	●	24	R76-1SS85-2RS
80	24	24	8	○	25	R80-2TS78-2RS
80	24	24	8	●	25	R80-2SS85-2RS
100	24	25	8	○	30	R100-1TS84-2RS
125	24	25	8	○	32	R125-1TS85-2RS



Plastfælg og polyurethan-dæk med LED'er | Plastic rim and polyurethane tyre with LEDs





80	24	25	8	🌈	25	R80-1TS85-2RS-LED
100	24	25	8	🌈	30	R100-1TS84-2RS-LED
125	24	25	8	🌈	32	R125-1TS85-2RS-LED



*LED-farver | *LED colours







Sølv aluminium letvægt hjul | Silver aluminium lightweight rim

Größe Size						Art-Nr. Art.-No.
4x1,4"	105	35	25	8	32	R105/35-SLSI-PUS
5x1,4"	125	35	25	8	35	R125/35-SLSI-PUS
6x1,4"	150	35	25	8	45	R150/35-SLSI-PUS



Sort aluminium letvægt hjul | Black aluminium lightweight rim

Größe Size						Art-Nr. Art.-No.
4x1,4"	105	35	25	8	32	R105/35-SLBL-PUS
5x1,4"	125	35	25	8	35	R125/35-SLBL-PUS
6x1,4"	150	35	25	8	45	R150/35-SLBL-PUS





CoMoRun hjul er designet af Rolko og produceres på vores egen fabrik. Dette letvægts hjul kommer i flere forskellige størrelser og fås i flere forskellige farver.

Hjulet er lavet af aluminium og er super letvægt. Det er designet til aktive brugere og sports brug. Purrbanen på hjulet er udviklet med en lav rullemodstand og skabt til hurtige bevægelser på banen.

Alle hjul leveres med rustfrie kuglelejer og derfor klar til brug inde som ude.







Rød aluminium letvægt hjul | Silver aluminium lightweight rim

Größe Size						Art-Nr. Art.-No.
4x1,4"	106	35	25	8	32	R105/35-SLRED-PUS
5x1,4"	125	35	25	8	35	R125/35-SLRED-PUS



Blå aluminium letvægt hjul | Black aluminium lightweight rim

Größe Size						Art-Nr. Art.-No.
4x1,4"	106	35	25	8	32	R105/35-SLBLU-PUS
5x1,4"	125	35	25	8	35	R125/35-SLBLU-PUS

Rollatorhjul | Rollator Wheels

Hjul med luftdæk | Wheels with Pneumatic Tyre

Plastfælg | Plastic rim

					Art-Nr. Art.-No.
150	30	36	8	35	R150/30-2-L-S
150	30	46	8	35	R150/30-2-L-S46
180	45	46	8	50	R180/45-3-LGS45
180	45	60	8	50	R180/45-3-LGSSK
200	50	60	8	60	R200/50-3LGSSK



Plastfælg | Plastic rim

					Art-Nr. Art.-No.	
200	30	38	8	40	R200/30-1-L-S38	
200	30	46	8	40	R200/30-1-L-S46	
200	30	60	8	40	R200/30-1-L-SSK	
310	55	63	9	40	R310/55-1-LGS-DK	Passer til Carl Oscar



2-delt plastfælg | 2-part plastic rim

					Art-Nr. Art.-No.
180	45	60	8	50	R180/45-2-LG-S
200	50	60	8	60	R200/50-2-LG-S



Få adgang til vores B2B Webshop!

Vi har en B2B webshop, hvor du kan, når det passer ind i din tidsplan, bestille varer! Vi opdatere shoppen løbende, så du altid har adgang til nyheder og anden brugbar produkt information.

www.RolkoShop.dk



Tilmeld dig nyhedsbrevet!

Ved at tilmelde dig vores nyhedsbrev, er du først til at få adgang til nyheder og gode tilbud fra Rolko. Tilmeld dig via info@rolko.dk



Hjul med polyurethan-dæk | Wheels with Polyurethan Tyre

Plastfælg til hulegerhjul | Hollow-spoke plastic rim



					Art-Nr. Art.-No.
150	30	36	8	30	R150/30-H3-PU-S
150	30	46	8	30	R150/30-H3-PU-S46
200	30	38	8	35	R200/30-H3-PU-S-38
200	30	46	8	35	R200/30-H3-PU-S-46
200	32	60	8	35	R200/32-H3-PU-S-46

Plastfælg | Plastic rim



					Art-Nr. Art.-No.	
150	32	24	8	30	R150/32-1-PU-G-MED	Passer til Jazzy kørestol
175	27	38	8	30	R175/27-1-PUS38	
175	27	46	8	30	R175/27-1-PUS46	
175	27	60	8	30	R175/27-1-PU-S	

Plastfælg til hulegerhjul | Hollow-spoke plastic rim



					Art-Nr. Art.-No.	
200	50	60	8	50	R200/50-H3-PU-SK	Passer til Kelvin kørestol
200	42	46	8	50	R200/42-H3-PU-SK	Passer På Kelvin Kørestol
320	55				R320/55-5-PUS-B	Passer til Kelvin kørestol

Plastfælg | Plastic rim



					Art-Nr. Art.-No.
125	30	36	8	28	R125/30-2-PU-S
175	40	46	8	45	R180/45-3-PUS45
175	40	60	8	45	R180/45-3-PU-SK
200	50	60	8	50	R200/50-3-PU-SK





2-delt plastfælg | 2-part plastic rim







					Art-Nr. Art.-No.
170	45	60	8	45	R180/45-2-PU-S
200	50	60	8	50	R200/50-2-PU103-S-60

Hjul med Gummibane | Wheels with Solid Rubber Tyre





Plastfælg | Plastic rim

    					Art-Nr. Art.-No.
100	32	36	8	30	R100/32-2-V-P
100	32	46	8	30	R100/32-2-V-P-46
100	32	33	10	30	R100/32-2-V-S10
125	32	36	8	35	R125/32-2-V-P
125	32	46	8	35	R125/32-2-V-P46
125	32	30	10	35	R125/32-2-V-S10



    					Art-Nr. Art.-No.
125	40	46	8	35	R125/40-1-V-46
125	40	60	8	35	R125/40-1-V
125	40	40	10	35	R125/40-1-V-S10
140	40	46	8	40	R140/40-1-V-46
140	40	60	8	40	R140/40-1-V
140	40	40	10	40	R140/40-1-V-S10







    					Art-Nr. Art.-No.
125	25	36	8	30	R125/25-2-V-S
125	25	46	8	30	R125/25-2-V-S46
125	25	32	10	30	R125/25-2-V-S10
150	25	36	8	30	R150/25-2-V-S
150	25	46	8	30	R150/25-2-V-S46
150	25	32	10	30	R150/25-2-V-S10
150	33	36	8	40	R150/33-2-V-8/36
150	33	46	8	40	R150/33-2-V-8/46
150	33	60	8	40	R150/33-2-V-8/60
150	33	32	10	40	R150/33-2-V-S10



    					Art-Nr. Art.-No.
125	37,5	43	8	50	R125/37.5-VLI6RS



    					Art-Nr. Art.-No.
140	40	46	8	40	R140/40-H3-V-46
140	40	60	8	40	R140/40-H3-V
178	35	46	8	45	R178/35-3-V-46
178	35	60	8	45	R178/35-3-V-S10
200	28	46	8	32	R200/28-H3-V-S46
200	28	60	8	32	R200/28-H3-V-S10



Hjul med punkteringsikkert indlæg | Wheels with Puncture-Proof Insert



Plastfælg med slidstærkt, punkteringsikkert indlæg Rolkofill |
Plastic rim with long-life puncture-proof insert Rolkofill

					Art-Nr. Art.-No.
150	30	36	8	30	R150/30-2-F-S
150	30	46	8	30	R150/30-2-F-S46



					Art-Nr. Art.-No.
180	45	46	8	40	R180/45-2-F-S45
180	45	60	8	40	R180/45-2-F-S-60
200	50	60	8	50	R200/50-2-F-S-IA2802-60



					Art-Nr. Art.-No.
150	30	36	8	30	R150/30-1-F-S
150	30	46	8	30	R150/30-1-F-S46
200	30	60	8	35	R200/30-1-F-S
200	30	46	8	35	R200/30-1-F-S46



					Art-Nr. Art.-No.
220	50	60	8	60	R220/50-3-F4GS

RolkoFILL

Vores punkteringsikre indlæg | Our puncture-proof insert
Meget slidstærkt | Very durable
Fremragende køreegenskaber | Excellent running characteristics

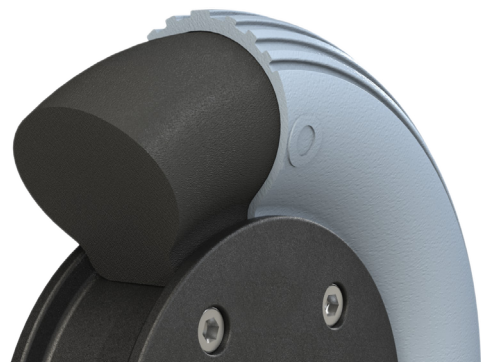

Dæktilbehør | Tyre Accessories



Plastdækjern til en skånsom montering af Pu-/luftdæk på fælg | Plastic tyre lever for a gentle assembly of PU and pneumatic tyres on rims

Art-Nr.
Art.-No.

ME-PU-RO

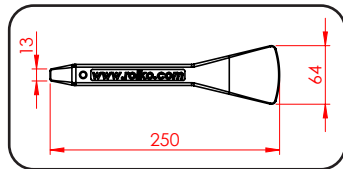

Ståldækjern til montering af dæk | Steel lever for the tyre assembly.

Art-Nr.
Art.-No.

ME-FL

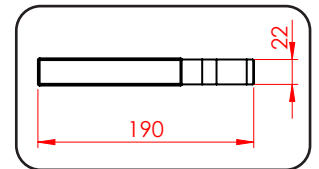

Schwalbe-dækjern til montering af dæk, sæt med 3 stk. | Schwalbe plastic lever from for tyre assembly, set with 3 pcs.

Art-Nr.
Art.-No.

RH-K



Schwalbe Doc Blue Professional: Forsegler til reparation eller som forebyggende punkteringssikring til slanger og slangedæk, 500 ml. | Sealant for the repair or preventive puncture protection of tubes and tubular tyres, 500 ml.

Art-Nr.
Art.-No.

PA-V-500ML



LP-VV

LP-ES

Gulvpumpe SKS Rennkompressor med ventilkonnek-tor AV/DV/SV, maks. tryk: 16 bar / 230 PSI. | Floor pump SKS Rennkompressor with thumb lock head AV/DV/SV, max. output: 16 bar / 230 PSI.

Art-Nr.
Art.-No.

Pumpe med slange |
Pump with hose

LP-SLK-AV-S

Ventilforlængelse |
Valve extension

LP-VV

Reserveslange |
Replacement hose

LP-ES

Fælgbånd beskytter slanger mod beskadigelse fra ender af eger på fælgens inderside | Rim bands protect the inner tubes against damages from spoke ends in the inner rim

	ETRTO	B	BAR	Art-Nr. Art.-No.
Standard	22-406	13	3,0	FB20x1.3/8
Standard	20-489/507	12	3,0	FB22x1.3/8
Standard	18-540	14	3,0	FB24x1.3/8
Standard	20-590	13	3,0	FB26x1.3/8
Polyurethan	16-540	16	10,0	FB-PU24x1
Polyurethan	20-559	19	10,0	FB-PU26x1-559



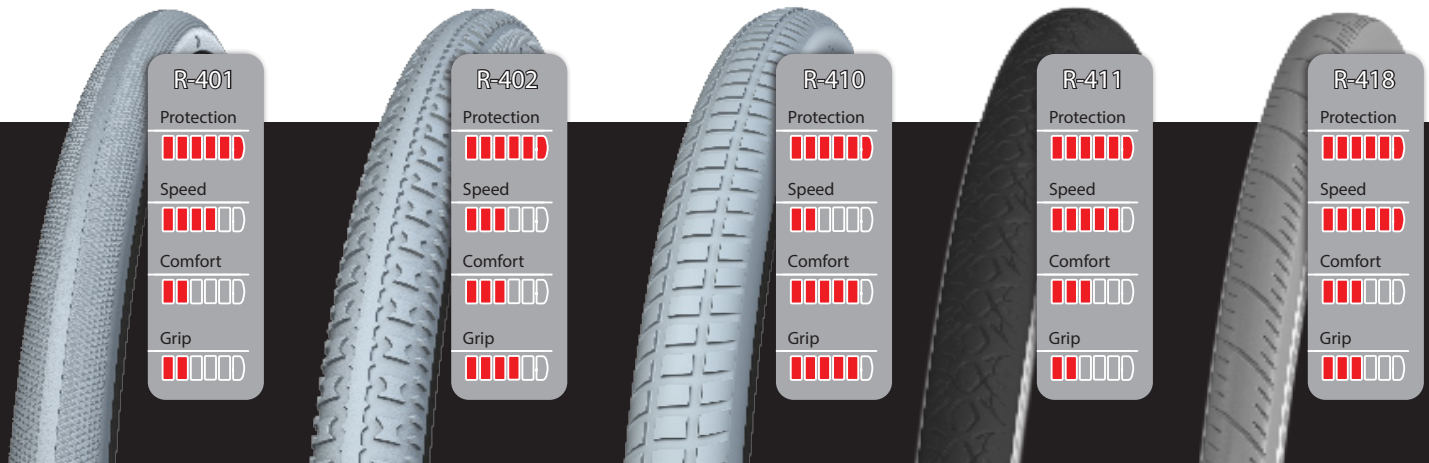

CLASSIC ALLROUNDER GRIP+COMFORT MODERN PROSPEED

PROFLEX Dual Density

Ved at kombinere en hård og blød pur blanding, opnår vi både øget komfort og forbedret greb - Samt en lavere rullemodstand. | By combining a harder and a softer compound, both increased driving comfort and improved grip are achieved with low rolling resistance.

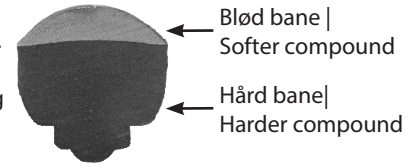

Größe Size	ETRTO	Colour				Art-Nr. Art.-No.	
20x1"	25-451	○	R-401	16	50	PU-R510/25-G-R401-16	
20x1"	25-451	●	R-401	16	50	PU-R510/25-S-R401-16	
20x1"	25-451	○	R-401	19	50	PU-R510/25-G-R401-21	
20x1"	25-451	●	R-401	19	50	PU-R510/25-S-R401-21	
20x1"	25-451	○	R-401	PROFLEX	19	50	PU-R510/25-G-R401-21-70/40
20x1"	25-451	●	R-401	PROFLEX	19	50	PU-R510/25-S-R401-21-70/40
20x1.3/8"	37-451	○	R-401	19	55	PU-R510/35-G-R401-21	
20x1.3/8"	37-451	○	R-402	19	55	PU-R510/35-G-R402	
20x1.75"	47-406	○	R-402	22	55	PU-R510/50-G-R402	
22x1"	25-489	○	R-401	16	50	PU-R570/25-G-R401-16	
22x1"	25-489	●	R-401	16	50	PU-R570/25-S-R401-16	
22x1"	25-489	○	R-401	19	50	PU-R570/25-G-R401-21	
22x1"	25-489	●	R-401	19	50	PU-R570/25-S-R401-21	
22x1"	25-489	○	R-401	PROFLEX	19	50	PU-R570/25-G-R401-21-70/40
22x1"	25-489	●	R-401	PROFLEX	19	50	PU-R570/25-S-R401-21-70/40
22x1.3/8"	37-489	○	R-401	19	55	PU-R570/35-G-R401-21	
22x1.3/8"	37-489	○	R-402	19	55	PU-R570/35-G-R402	
22x1.3/8"	37-501	○	R-402	19	55	PU-R37-501-G-R402	
24x1"	25-540	●	R-411	16	60	PU-R620/25-S-R411	
24x1"	25-540	○	R-401	16	60	PU-R620/25-G-R401-16	
24x1"	25-540	●	R-401	16	60	PU-R620/25-S-R401-16	

Polyurethan-dæk | Polyurethane Tyres

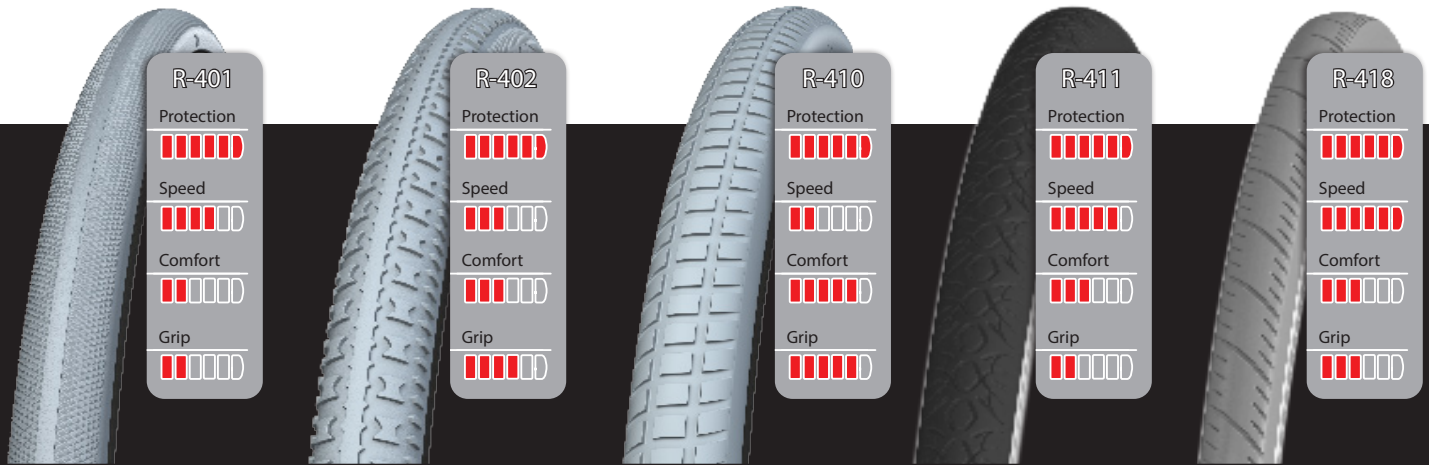

CLASSIC ALLROUNDER GRIP+COMFORT MODERN PROSPEED

PROSPEED

PROSPEED pur dækket er specielt designet til høje hastigheder og at have en meget lav rullemodstand |

The PROSPEED tyres with their unique design, special tread and PU compound allow high speed with minimal rolling resistance.

Größe Size	ETRTO	Colour				Art-Nr. Art.-No.
24x1"	25-540	○	R-401		19 60	PU-R620/25-G-R401-20
24x1"	25-540	●	R-401		19 60	PU-R620/25-S-R401-20
24x1"	25-540	○	R-401	PROFLEX	19 60	PU-R620/25-G-R401-20-70/40
24x1"	25-540	●	R-401	PROFLEX	19 60	PU-R620/25-S-R401-20-70/40
24x1"	25-540	○	R-402		19 60	PU-R620/25-G-R402-20
24x1"	25-540	●	R-402		19 60	PU-R620/25-S-R402-20
24x1"	25-540	○	R-418	PROSPEED	19 60	PU-R620/25-G-R418
24x1"	25-540	●	R-418	PROSPEED	19 60	PU-R620/25-S-R418
24x1.3/8"	37-540	○	R-401		19 65	PU-R620/35-G-R401
24x1.3/8"	37-540	○	R-410		19 65	PU-R620/35-G-R410-01
24x1.3/8"	37-540	●	R-410		19 65	PU-R620/35-S-R410-01
24x1.3/8"	37-540	○	R-402		19 65	PU-R620/35-G-R402
24x1.3/8"	37-540	●	R-402	PROFLEX	19 65	PU-R620/35-S-R402-70/40
24x1.3/8"	37-540	○	R-402	PROFLEX	19 65	PU-R620/35-G-R402-70/40
25x1"	25-559	○	R-401		19 55	PU-R630/25-G-R401-20
25x1"	25-559	○	R-418	PROSPEED	19 65	PU-R630/25-G-R418
25x1"	25-559	●	R-418	PROSPEED	19 65	PU-R630/25-S-R418
26x1"	25-590	○	R-401		19 60	PU-R670/25-G-R401
26x1"	25-590	○	R-401		19 60	PU-R670/25-S-R401
26x1"	25-590	●	R-401	PROFLEX	19 60	PU-R670/25-G-R401-70/40
26x1"	25-590	●	R-401	PROFLEX	19 60	PU-R670/25-S-R401-70/40
26x1.3/8"	37-590	○	R-402		19 65	PU-R670/35-G-R402



Marathon Plus Evolution

Punkteringer hører fortiden til!

- Bliver ikke flade, på grund af SmartGuard
- Sort, slidstærk gummisammensætning, der ikke efterlader mørke dækaftryk
- Skånsom for hænderne med 2Grip

Marathon Plus Evolution

Punctures are a thing of the past!

- Flat-less SmartGuard
- Black, durable rubber compound that does not leave tyre marks
- With 2Grip, gentle for the hands

Størrelse Size	ETRTO	Colour	BAR		Art-Nr. Art.-No.
24x1"	25-540	●	6 - 10	60	D24x1-S-MPE
24x1.12"	28-540	●	6 - 10	60	D24x1.12-S-MPE
24x1.3/8"	37-540	●	3,5 - 6	75	D24x1.3/8-S-MP2G
26x1"	25-559	●	6 - 10	60	D26x1-559-S-MPE
26x1"	25-590	●	6 - 10	65	D26x1-S-MPE



Marathon Plus Evolution Reflex

Med refleksstriber på siderne

Marathon Plus Evolution Reflex

With reflective strips on the side walls

Størrelse Size	ETRTO	Colour	BAR		Art-Nr. Art.-No.
22x1"	25-489	● / Reflex	6 - 10	55	D22x1-S-MPE-REF
24x1"	25-540	● / Reflex	6 - 10	60	D24x1-S-MPE-REF

Marathon Plus Performance

Kombinerer komfort og en let kørsel på luftdæk.

Med indlæg med punkteringssikring

Med SmartGuard kan du køre frit gennem glasskår. Nu med 2grip: De helt glatte sider er skånsomme for hænderne.

Marathon Plus Performance

Combines the comfort and low rolling resistance of a pneumatic tyre with puncture protection of PU tyre. The puncture protection belt SmartGuard can even handle a patch of broken glass. And now with 2grip: Totally smooth sidewalls, gentle for the hands.



Størrelse Size	ETRTO	Colour	BAR		Art-Nr. Art.-No.
24x1"	25-540	● / ●	6 - 10	60	D24x1-GS-MP2G
24x1.3/8"	37-540	● / ●	3,5 - 6	75	D24x1.3/8-GS-MP2G

Dæk til aktivstole | Activity Tyres



RightRun

Basismodellen fra Schwalbe: Med puncture protection indlæg, 2Grip side som er skånsom for hænderne, og en attraktiv gummisammensætning i to farver.

RightRun

Entry level model from Schwalbe: effective puncture protection layer, hand-friendly 2Grip side walls, and attractive two color compound.

Størrelse Size	ETRTO	Colour	BAR		Art-Nr. Art.-No.
20x1"	25-451	● / ●	6 - 10	50	D20x1-RR
20x1"	25-451	● / ●	6 - 10	50	D20x1-RR-S
22x1"	25-489	● / ●	6 - 10	55	D22x1-RR
22x1"	25-501	● / ●	6 - 10	55	D22x1-RR-501
22x1"	25-451	● / ●	6 - 10	55	D22x1-RR-S
24x1"	25-540	● / ●	6 - 10	60	D24x1-RR
24x1"	25-540	● / ●	6 - 10	60	D24x1-RR-B
24x1"	25-540	● / ●	6 - 10	60	D24x1-RR-R
24x1"	25-540	● / ●	6 - 10	60	D24x1-RR-S
24x1.12"	28-540	● / ●	6 - 10	60	D24x1.12-RR
26x7/8"	23-559	● / ●	6 - 10	60	D26x1-559-RR
26x1"	25-590	● / ●	6 - 10	65	D26x1-RR
26x1"	25-590	● / ●	6 - 10	65	D26x1-RR-S



RightRun Plus

Slick dæk Med puncture protection indlæg SmartGuard, der sørger for at du ikke får flade dæk.

RightRun Plus

Slick tyre with the flatless puncture protection belt SmartGuard.

Størrelse Size	ETRTO	Colour	BAR		Art-Nr. Art.-No.
22x1"	25-489	● / ●	6 - 10	55	D22x1-RR-P
24x1"	25-540	● / ●	6 - 10	60	D24x1-RR-P



One

Hurtigt og pålideligt foldedæk fra Schwalbe. Stilfuldt profildesign og forbedret Wheelstar gummisammensætning med en høj grad af punkteringssikring takket være den højteknologiske fiber V-Guard.

One

Fast and reliable folding tyre from Schwalbe. Stylish tread design and Wheelstar compound with a high degree of puncture resistance due to the high-tech fiber V-Guard.

Størrelse Size	ETRTO	Colour	BAR		Art-Nr. Art.-No.
24"	25-540	●	6 - 9	60	D24x0.90-S-HS462
26"	25-559	●	6 - 9	70	D26x0.90-S-HS462





Dæk til aktivstole | Activity Tyres

Downtown

Allround-dæk med greb og komfort. Med indlæg til punkteringssikring Kevlar® Guard og 2Grip side, der er skånsom for hænderne.



Downtown

All-rounder with grip and comfort. With puncture protection belt Kevlar® Guard and hand-friendly 2Grip side walls.

ETRTO		Colour	BAR		Art-Nr. Art.-No.
24x1"	25-540	●	6 - 10	60	D24x1-S-DT
24x1"	25-540	● / ●	6 - 10	60	D24x1-G-DT-SW
24x1.3/8"	37-540	● / ●	3,5 - 5	75	D24x1.3/8-G-DT

Big Ben

Balloon-dækket fra Schwalbe imponerer med en slidstærk Endurance-Compound, en pålidelig punkteringssikring og et unikt look.



Big Ben

The balloon tyre from Schwalbe convinces with a durable endurance compound, reliable puncture protection and a striking look.

ETRTO		Colour	BAR		Art-Nr. Art.-No.
24x2.15"	55-507	● / Reflex	2 - 4	118	D24x2.15-S

Land Cruiser

Det er udrustet til ethvert terræn med sit moderne profildesign, og ruller ligeledes behageligt let på vejen.



Land Cruiser

With a modern tread design it is always ready for any kind of terrain, but it also rolls easily on the road.

ETRTO		Colour	BAR		Art-Nr. Art.-No.
24"	47-507	●	3 - 5	85	D24x1.75-S-HS450
24"	50-507	●	2,5 - 5	85	D24x1.90-HS450

Dæk til aktivstole | Activity Tyres

Dunk King

Dette Schwalbe dæk er specialiseret til indendørs sport. Designet til at være ekstremt next at vende og have lav rullemodstand i kørestolen. Specielt godt til stole med negativ camber.

Dunk King

The specialist of Schwalbe for indoor sports, extremely easy to turn and roll, designed for negative camber of the wheels on indoor sports wheelchairs.

Größe Size	ETRTO	Colour	BAR		Art-Nr. Art.-No.
24x1"	25-540	○/●	6 - 10	70	D24x1-G-DK
26x1"	25-559	○/●	6 - 10	70	D26x1-559-G-DK
26x1"	25-590	○/●	6 - 10	70	D26x1-G-DK



Koncept K191 og Kontender K196

Fantastisk allround dæk, både til alm. udendørs brug og mere aktivt sports brug. Dækket har gode accelerations og sving egenskaber.

Koncept K191 and Kontender K196

Excellent all purpose road and activity tyres, giving you great acceleration and cornering characteristics.

Größe Size	ETRTO	Colour		Art-Nr. Art.-No.	
24x1"	23-540		60	D24x1-B-K191	●/●
24x1"	23-540		60	D24x1-GE-K191	●/●
24x1"	23-540		60	D24x1-R-K191	●/●
25x1"	23-559		60	D25x1-B-K191	●/●
25x1"	23-559		60	D25x1-GE-K191	●/●
25x1"	23-559		60	D25x1-R-K191	●/●
26x1"	23-590		65	D26x1-B-K196	●/●
26x1"	23-590		65	D26x1-GE-K196	●/●
26x1"	23-590		65	D26x1-R-K196	●/●

KENDA

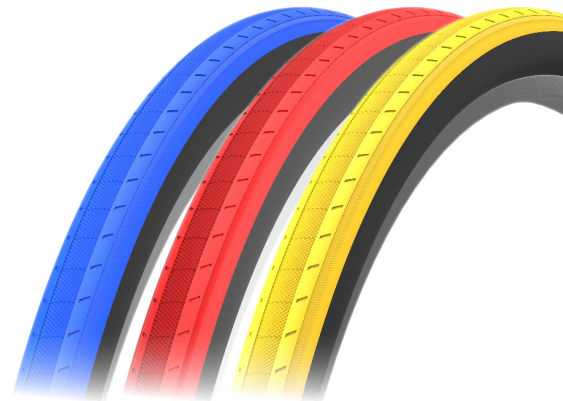

VN MASTER

by CST

Alpha Protect

Maximal punkterings beskyttelse med den laveste vægt. Dækket er special udviklet til kørestole med et let rullende og komfortabelt mønster og er let ved hænderne.

Alpha Protect

Maximum puncture protection with lowest weight, specially developed for wheelchairs, handy, smooth-running and comfortable tread, non-marking and gentle on hands.

Größe Size	ETRTO	Colour	BAR		Art-Nr. Art.-No.
22x1"	25-489		6 - 10	60	D22x1-S-VNM-AP
24x1"	25-540	●	6 - 10	60	D24x1-S-VNM-AP
25x1"	25-559	●	6 - 10	60	D26x1-559-S-VNM-AP
26x1"	25-590	●	6 - 10	60	D26x1-S-VNM-AP



Dæk til manuelt betjente kørestole | Tyres for Manually Operated Wheelchairs

Profil



R-102



R-103































R-105



R-106



R-107

Størrelse Size	ETRTO			BAR		Art-Nr. Art.-No.
6 x 1.1/4	32-86	Dæk Tyre	R 103	2.5		D150/30-G
	32-86	Dæk Tyre	R 115	2.5		D150/30-G-SL
	32-86	Dæk Tyre	R 103	2.5		D150/30-S-IA-2802
7 x 1.3/4	47-93	Dæk Tyre	R 103	2.5		D180/45-G-SO
	47-93	Dæk Tyre	R 102	2.5		D180/45-S-IA-2611
8 x 1.1/4	32-137	Dæk Tyre	R 103	2.5		D200/30-G
8 x 2 200 x 50	50-94	Dæk Tyre	R 103	2.5		D200/50-G-SO
	50-94	Dæk Tyre	R 116	2.5		D200/50-GBB
	50-94	Dæk Tyre	R 103	2.5		D200/50-S-SO
	50-94	Dæk Tyre	R 103	2.5		D200/50-G
	50-94	Dæk Tyre	R 103	2.5		D200/50-S
	50-94	Dæk Tyre	R 103	2.5		D200/50-G-CS
	50-94	Dæk Tyre	R 103	2.5		D200/50-S-C179
10 x 2	54-152	Dæk Tyre	R 103	2.5		D250/50-G-I
	54-152	Dæk Tyre	R 102	2.5		D250/55-S-IA-2611
	54-152	Dæk Tyre	R 103	2.5		D250/50-G
	54-152	Dæk Tyre	R 103	2.5		D250/50-S
12.1/2 x 2.1/4	47-203	Dæk Tyre	R 120	2.5		D310/40-S-47-203
	57-203	Dæk Tyre	R 105	2.5		D310/55-G-C51
	57-203	Dæk Tyre	R 105	2.5		D310/55-S-C51
	62-203	Dæk Tyre	R 105	2.5		D310/55-G-R105
	62-203	Dæk Tyre	R 105	2.5		D310/55-S-R105
	62-203	Dæk Tyre	R 102	2.5		D310/55-S-IA-2611
	62-203	Dæk Tyre	R 106	2.5		D310/55-G-M
	62-203	Dæk Tyre	R 107	2.7		D310/55-G-V
	62-203	Dæk Tyre	R 107	2.7		D310/55-S-V

Dæk til manuelt betjente kørestole | Tyres for Manually Operated Wheelchairs



R-116

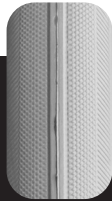

R-118



R-119











SRI133



R-124

Profil

Størrelse Size	ETRTO	high-pressure	 Colour	 SRI	BAR	 PUNCTURE PROTECTION	Art-Nr. Art.-No.
20 x 1	25-451	Højtryks-dæk	●	R 118	7.5		D20x1-H-G
22 x 1	25-489	Højtryks-dæk	●	R 118	7.5		D22x1-H-G-SCHWA
	25-498	Højtryks-dæk	●	R 118	7.5		D22x1-CS-G-498
24 x 1	25-540	Højtryks-dæk	●	R 118	10.0		D24x1-H-G-SCHWA
	25-540	Højtryks-dæk	○/●	R 119	10.0		D24x1-H-G-SB
	25-540	Højtryks-dæk	○/●	R 118	10.0		D24x1-H-G-SW
	25-540	Højtryks-dæk	●	R 103	5-7		D24x1-H-G-IS105

Størrelse Size	ETRTO		 Colour	 SRI	BAR	Art-Nr. Art.-No.
20 x 1.3/8	37-451	Dæk Tyre	●	R 124	4.0	D20x1.3/8-G
20 x 1.75	47-406	Dæk Tyre - Med Reflex	●	R 120	4.0	D20x1.75-S-BS100-REF
	47-406	Dæk Tyre	●	C 97	4.0	D20x1.75-G-C97
22 x 1.3/8	37-489	Dæk Tyre	●	R 124	4.0	D22x1.3/8-G
	32-498	Dæk Tyre	●	R 103	4.0	D22x1.3/8-G-498
	37-501	Dæk Tyre	●	R 124	4.0	D22x1.3/8-G-501
	37-540	Dæk Tyre	●	R 124	4.0	D24x1.3/8-G
	37-540	Dæk Tyre	●	R 103	6.5	D24x1.3/8-G-SUP
24 x 1.3/8	37-540	Dæk Tyre	●	R 119	5.0	D24x1.3/8-G-AW
	37-540	Dæk M/Puncture Protection	●	R 121	5.0	D24x1.3/8-SAFE-G
24 x 1.75	47-507	Dæk Tyre	●	R 120	3.0	D24x1.75-G
26 x 1.3/8	37-590	Dæk Tyre	●	R 119	4.0	D26x1.3/8-G-IS102
26 x 1.75	47-559	Dæk Tyre - Med Reflex	●	R 125	3.0	D26x1.75-S-HS307R

Dæk til manuelt betjente kørestole | Tyres for Manually Operated Wheelchairs

Profil



R-101



R-103



R-104



R-105

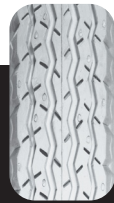

R-108



R-109



R-110

Størrelse Size	ETRTO		Colour	BAR	Art-Nr. Art.-No.	
20 x 1.3/8	37-451	Dæk Tyre	●	R 124	4.0	D20x1.3/8-G
20 x 1.75	47-406	Dæk Tyre - Med Reflex	●	R 120	4.0	D20x1.75-S-BS100-REF
	47-406	Dæk Tyre	●	C 97	4.0	D20x1.75-G-C97
22 x 1.3/8	37-489	Dæk Tyre	●	R 124	4.0	D22x1.3/8-G
	32-498	Dæk Tyre	●	R 103	4.0	D22x1.3/8-G-498
	37-501	Dæk Tyre	●	R 124	4.0	D22x1.3/8-G-501
	37-540	Dæk Tyre	●	R 124	4.0	D24x1.3/8-G
24 x 1.3/8	37-540	Dæk Tyre	●	R 103	6.5	D24x1.3/8-G-SUP
	37-540	Dæk Tyre	●	R 119	5.0	D24x1.3/8-G-AW
	37-540	Dæk M/Puncture Protection	●	R 121	5.0	D24x1.3/8-SAFE-G
24 x 1.75	47-507	Dæk Tyre	●	R 120	3.0	D24x1.75-G
26 x 1.3/8	37-590	Dæk Tyre	●	R 119	4.0	D26x1.3/8-G-IS102
26 x 1.75	47-559	Dæk Tyre - Med Reflex	●	R 125	3.0	D26x1.75-S-HS307R



Dæk til el-kørestole og scootere | Tyres for Power Chairs and Scooters



R-111

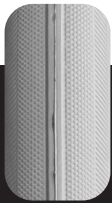

R-118



R-121



R-125

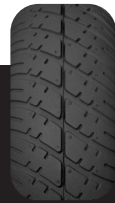

R-126



R-129



R-130

Profil

Luftdæk Med Puncture Protection

Størrelse Size			BAR	Art-Nr. Art.-No.
200 X 50 (8 X 2)	Dæk Tyre	R 103	2.5	D200/50-G-PP
2.80/2.50-4	Dæk Tyre	R 101	3.5	D260/85-GB-PP
3.00-4 (260/85)	Dæk Tyre	R 104	2.5	D260/85-G-Racin-PP
4.00-5	Dæk Tyre	R 101	3.5	D4.00-5-GB-CY270-PP
4.00-5	Dæk Tyre	R 101	3.5	D4.00-5-SB-CY270-PP
2.50-8	Dæk Tyre	R 101	3.5	D2.50-8-GB4-PP
3.00-8	Dæk Tyre	R 107	2.5	D3.00-8-GB-CY145-PP
3.00-8	Dæk Tyre	R 101	2.5	D3.00-8-SB-CY145-NM-PP
3.00-8	Dæk Tyre	R 104	3.5	D3.00-8-G-Highw-IS306-PP
3.00-10	Dæk Tyre	R 101	2.5	D3.00-10-G-High-PP
3.00-10	Dæk Tyre	R 114	2.5	D3.00-10-GB-PP
12.1/4 X 2.1/4	Dæk Tyre	R 107	2.5	D310/55-G-V-PP
12.1/4 X 2.1/4	Dæk Tyre	R 107	2.5	D310/55-S-V-PP
12.1/4 X 2.1/4	Dæk Tyre	R 107	2.5	D310/55-G-M-PP
13x5.00-6	Dæk Tyre	R 107	3.0	D13x5.00-6-GB-PP

Panser Indlæg - El Scooter

Størrelse Size	Art-Nr. Art.-No.
3.00-4"	U-V-PR-3.00-4
4.10/3.50-6" & 4.00-5" & 4.00-4"	U-V-PR-4.10/3.50-6
13 X 5.00-6"	U-V-PR-13x5.00-6
3.00-8"/2.50-8"	U-V-PR-3.00-8

Panserringen ligger mellem slangen og dækket og yder en ekstra sikkerhed mod punkteringer. Panserringene kan være et alternativ til f.eks massive dæk og som gør, at du beholder den optimale køreegenskab, som du har ved luftdæk.

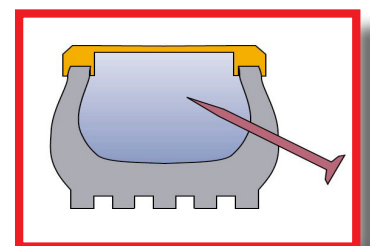

Slanger - El kørestole & Scooter

Størrelse Size	Ventil Valve	!	Art-Nr. Art.-No.
8.1/2 x 2 (220/120 x 50)	AV 90/35° ventil		S220/120-50-AV
2.50 - 3 (210 x 65)	AV 90/90° ventil		S210/65-AV
2.80/2.50-4 (230 x 65)	AV 90/90° ventil	TR 87	S2.50-4-AV
3.00-4 (260 x 85)	AV 90/90° ventil	TR 87	S260/85-AV
4.10/3.50-4 (4.00-4)	AV 90/90° ventil	TR 87	S4.00-4-AV
4.10/3.50-5	AV 90/90° ventil	TR 87	S4.10/3.50-5-AV
2.50-6	AV 90/90° ventil	TR 87	S2.50-6-AV-W
3.00-6	AV 90/90° ventil	TR 87	S3.00-6-AV
4.10/3.50-6	AV 90/90° ventil	TR 87	S4.10/3.50-6-AV
5.30/4.50-6	AV 90/90° ventil	TR 87	S5.30/4.50-6-AV
13 x 5.00-6	AV 90/90° ventil	TR 87	S13x5.00-6-AV
13 x 5.00-6	AV Lige ventil		S13x5.00-6-AV-G
2.50-8	AV 90/90° ventil	TR 87	S2.50-8-AV-W
3.00-8	AV 90/90° ventil	TR 87	S3.00-8-AV
3.00-8	AV Lige ventil		S3.00-8-AV-G
3.50/4.00-8	AV 90/90° ventil	TR 87	S3.50-8-AV-W
12.5 x 4.00-8	AV 90/90° ventil	TR 87	S12.5x4.00-8-AV-W
4.00-8 (400 x 100)	AV Lige ventil		S400/100-AV
4.00-8 (400 x 100)	AV 90/90° ventil	TR 87	S400/100-AV-W
3.00-10	AV Lige ventil		S3.00-10-AV
3.00-10	AV 90/90° ventil	TR 87	S3.00-10-AV-W
3.50-10	AV 90/90° ventil	TR 87	S3.50-10-AV-W

Oversigt over ventiler | Overview of Valve Positions



Lige | Straight



AV 90/45°

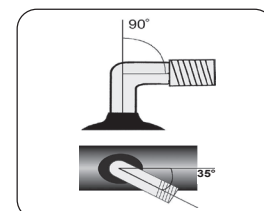

AV 90/35°



AV 90/90°

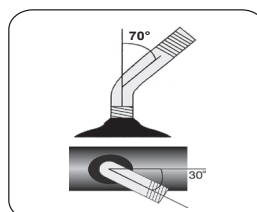

AV 70/30°



AV 30/45°

Slanger - standard kørestole

Størrelse Size	ETRTO	Ventil Valve	Art-Nr. Art.-No.
6 x 1.1/4	32-86	AV 70/30°	S150/30-AV
7 x 1.3/4	47-93	AV 90/30°	S200/50-AV-S-INC
7 x 1.3/4	47-93	AV 90/90°	S200/50-AV-N-INC
8 x 1.1/4	32-137	AV 45/30°	S200/30-AV-A-INC
200 x 50	50-94	AV 90/30°	S200/50-AV-S-INC
200 x 50	50-94	AV 90/90°	S200/50-AV-N-INC
10 x 2	54-152	AV 45/30°	S250/50-AV-INC
10 x 2	54-152	AV 90/90°	S250/50-AV-W-INC
10 x 2	54-152	AV Lige ventil	S250/50-AV-G-INC
12.1/2 x 2.1/4	62-203	AV Lige ventil	S310/55-AV
12.1/2 x 2.1/4	62-203	AV 90/90°	S310/55-AV-W
12.1/2 x 2.1/4	62-203	AV 45/45°	S310/55-AV45
20 x 1	25-451	AV Lige ventil	S20x1-AV
22 x 1	25-489	AV Lige ventil	S22x1-AV
24 x 1	25-540	AV Lige ventil	S24x1-AV
24 x 1	25-540	FV-Racer ventil	S24x1-SCV
26 x 1	20-559	AV Lige ventil	S26x1-559-AV
26 x 1	20-559	FV-Racer ventil	S26x1-559-SCV
26 x 1	25-590	AV Lige ventil	S26x1-AV
26 x 1	25-590	FV-Racer ventil	S26x1-SCV
20 x 1.3/8	37-451	AV Lige ventil	S20x1.3/8-AV
20 x 1.75	47-406	AV Lige ventil	S20x1.75-AV
22 x 1.3/8	37-489	AV Lige ventil	S22x1.3/8-AV
24 x 1.3/8	37-540	AV Lige ventil	S24x1.3/8-AV
24 x 1.75	47-507	AV Lige ventil	S24x1.75-AV
26 x 1.3/8	37-590	AV Lige ventil	S26x1.3/8-AV
26 x 1.75	47-559	AV Lige ventil	S26x1.75-AV



Punkteringsfrie dæk | Puncture-Proof Tyres

Profil



IS-326



R-101



R-103



R-104



R-107

Dæk, sorte eller grå, sporfri, med rem til punkteringssikring |
Tyres, grey oder black, non-marking, with puncture protection belt

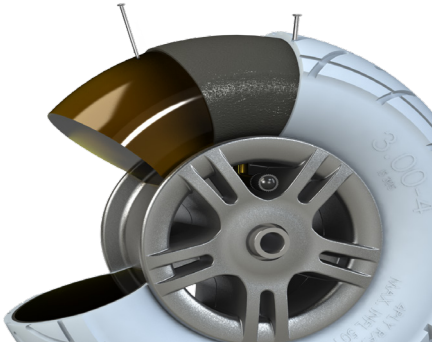
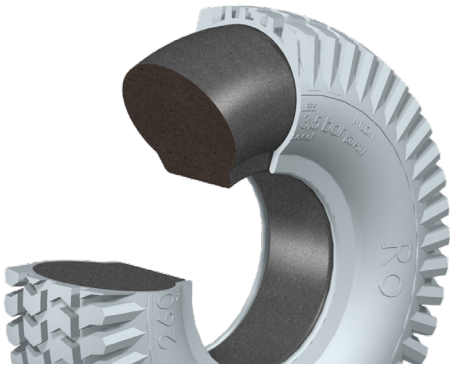

Rolko Inlet

Størrelse Size			Art-Nr. Art.-No.
7x1.3/4	R103	28	FL180/45-DG-C179
200 x 50	R103	28	AA200/50-DG-28-CY240
200 x 50	R103	28	AA200/50-DS-28-CY240-NM
2.50-3	R103	42	FL2.50-3-DGR
2.50-3	R101	42	FL2.50-3-DGB
2.80/2.50-4	R103	55	AA2.80/2.50-4-DGR-55-CY240
2.80/2.50-4	R108	55	AA2.80/2.50-4-DGM-55-CY243
3.00-4	R101	58	FL260/85-DGB-58
3.00-4	R101	68	FL260/85-DGB
3.00-4	R101	58	FL260/85-DSB
3.00-4	R101	68	FL260/85-DSB-68
4.00-5	R111	65	AA4.00-5-DGB-65-CY270
4.00-5	R111	65	FL4.00-5-DSB
3.00-8	R101	38	AA3.00-8-DGB-38-CY145
3.00-8	R101	55	AA3.00-8-DGB-55-CY145
3.00-8	R101	38	AA3.00-8-DSB-38-CY145-NM
3.00-8	R101	55	AA3.00-8-DSB-55-CY145-NM
3.00-8	R101	58	AA3.00-8-DS-CY145-ZL-58 (Quantum og MC1124)

Indlæg af polyurethan-skum, løst, til indsættelse i dæk |
Polyurethane foam inlay, loose, to insert into tyres

Størrelse Size		Art-Nr. Art.-No.
24x1"	23 - 24 mm	AA24x1*
24x1.3/8"	27 - 29 mm	AA24x1.3/8**

*Velegnet til D24x1-H-GSB | Suitable for D24x1-H-GSB. **Velegnet til D24x1.3/8-G | Suitable for D24x1.3/8-G

Dæk til EL-kørestole og EL scooter



R-101



R-103



R-104

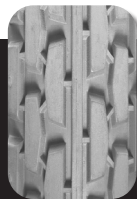

R-107

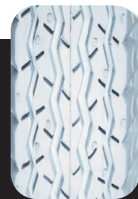



R-108



R-109



UN223

		 Colour		BAR		Art-Nr. Art.-No.
220/120 x 50 8 1/2 x 2	Dæk Tyre	●	R 103	2.5	4 PR	D220/120-50-S
	Dæk Tyre	●	R 103	2.5	4 PR	D220/120-50-G4
200 x 50	Dæk Tyre	●	R 103	2.5	4 PR	D200/50-G-SO
	Dæk Tyre	●	R 103	2.5	4 PR	D200/50-S-SO
2.50-3 210x65	Dæk Tyre	●	R 109	2.5	4 PR	D210/65-GB4-I
	Dæk Tyre	●	R 103	2.5	4 PR	D210/65-GR4
	Dæk Tyre	●	R 103	2.5	4 PR	D210/65-SR4
2.80/2.50-4 230 x 65	Dæk Tyre	●	R 108	2.5	4 PR	D2.80/2.50-4-GB
	Dæk Tyre	●	R 108	2.5	4 PR	D2.80/2.50-4-SB
	Dæk Tyre	●	R 103	2.5	4 PR	D2.80/2.50-4-GR-CY240-PP
3.00-4 260x85	Dæk Tyre	●	R 103	2.5	4 PR	D260/85-GR
	Dæk Tyre	●	R 101	2.5	4 PR	D260/85-GB-N
	Dæk Tyre	●	R 101	2.5	4 PR	D260/85-SB-N
	Dæk Tyre	●	R 104	2.5	4 PR	D260/85-G-Racin
	Dæk Tyre	●	R 104	2.5	4 PR	D260/85-S-Racin
4.10/3.50-4	Dæk Tyre	●	R 110	2.5	4 PR	D4.10/3.50-4-GB
4.00-5 330 x 100	Dæk Tyre	●	R 111	3.5	4 PR	D4.00-5-GB-CY270
	Dæk Tyre	●	R 111	3.5	4 PR	D4.00-5-SB-CY270-NM-PP
4.10/3.50-5	Dæk Tyre	●	R 110	3.5	4 PR	D4.10/3.50-5-GB
2.50-6	Dæk Tyre	●	R 107	3.5	4 PR	D2.50-6-SB4
	Dæk Tyre	●	R 107	3.5	4 PR	D2.50-6-GB
3.006	Dæk Tyre	○	R 104	3.5	4 PR	D3.00-6-GRAC
90/70-6	Dæk Tyre	●	UN223	3.5	4 PR	D90/70-6-S-UN223
4.10/3.50-6	Dæk Tyre	○	R 110	2.5	4 PR	D4.10/3.50-6-GB
	Dæk Tyre	●	R 110	2.5	4 PR	D4.10/3.50-6-SB

IMPAC & Rolko

IMPAC & Rolko



R-110



R-111





R-112



R-113



R-114

Størrelse Size		 Colour	 BAR	 !	Art-Nr. Art.-No.	
13 x 5.00-6	Dæk Tyre	○	R-112	3.5	4 PR	D13x5.00-6-GB
2.50-8	Dæk Tyre	○	R-107	2.5	4 PR	D2.50-8-GB4
	Dæk Tyre	○	R-101	2.5	4 PR	D3.00-8-GB-CY145
3.00-8	Dæk Tyre	●	R-101	2.5	4 PR	D3.00-8-SB-CY145-NM-PP
	Dæk Tyre	○	R-104	2.5	4 PR	D3.00-8-G-Highw
	Dæk Tyre	●	R-104	2.5	4 PR	D3.00-8-S-Highw
100/60-8	Dæk Tyre	○	R-101	2.5	4 PR	D3.00-8-GB-CY145
	Dæk Tyre	○	UN223	2.5	4 PR	D100/60-8-S-UN223
115/55-8	Dæk Tyre	●	UN223	2.5	4 PR	D115/55-8-S-UN223
		●				
4.00-8 (400x100)	Dæk Tyre	○	R-113	2.5	4PR	D400/100-GB-I
	Dæk Tyre	○	R-114	2.0	4 PR	D3.00-10-GB
3.00-10	Dæk Tyre	●	R-114	2.0	4 PR	D3.00-10-SB
	Dæk Tyre	○	R-104	2.5	4 PR	D3.00-10-G-High
	Dæk Tyre	●	R-104	2.5	4 PR	D3.00-10-S-High
3.50-10	Dæk Tyre	○	R-114	2.5	4PR	D3.50-10-GB



Dæk til El-Scooter !!

I dag findes der mange muligheder når vi snakker dæk til el-scooter. Vi hos Rolko kan tilbyde luft dæk med slange, eller dæk fyldt med flexel som gør dækket 100% punkterfri. Vi tilbyder også Rolko Smart som er en gummimasse der bliver presset ind i slangen. Dette gør at dækket beholder de gode køreegenskaber og samtidig bliver dækket også punkterfri. Vi kan tilbyde at smarte kundens egne hjul, således at der kun er udgiften til den gummimasse vi bruger.

Kontakt os for yderligere information

Tlf. 8720 1888

Mail: info@rolko.dk

CST Dæk til EL-kørestole og EL scooter



C-154



C-156



C-178



C-179



C-189





C-203



C-248





C-920

Størrelse Size	 Colour	 BAR		Art-Nr. Art.-No.		
200 x 50	Dæk Tyre	●	C 179	2.5	4 PR	D200/50-G-CS
	Dæk Tyre	●	C 179	2.5	4 PR	D200/50-S-C179
	Dæk Tyre	●	C 968	2.5	4 PR	D200/50-GBB
2.50-3 210x65	Dæk Tyre	●	C 179	2.5	4 PR	D210/65-G-C179
	Dæk Tyre	●	C 179	2.5	4 PR	D210/65-S-C179
	Dæk Tyre	●	C 248	2.5	4 PR	D210/65-GB-CS
2.80/2.50-4 230 x 65	Dæk Tyre	●	C 178	2.5	4 PR	D2.80/2.50-4-GB-CS
	Dæk Tyre	●	C 178	2.5	4 PR	D2.80/2.50-4-S-C178
	Dæk Tyre	●	C 179	2.5	4 PR	D2.80/2.50-4-G-C179
3.00-4	Dæk Tyre	●	C 179	2.5	2 PR	D260/85-S-C179
	Dæk Tyre	●	C 179	2.5	4 PR	D260/85-G-C179
	Dæk Tyre	●	C 248	2.5	4 PR	D260/85-S-C248
	Dæk Tyre	●	C 248	2.5	4 PR	D260/85-GB4-CS
	Dæk Tyre	●	C 920	2.5	4 PR	D260/85-S-C920
4.00-4	Dæk Tyre	●	C 920	2.5	4 PR	D260/85-G-C920
	Dæk Tyre	●	C 248	3.5	4 PR	D4.00-4-SB-C248-4PR
4.10/3.50-4	Dæk Tyre	●	C 248	3.5	4 PR	D4.00-4-GB-C248-4PR
	Dæk Tyre	●	C 156	3.5	4 PR	D4.10/3.50-4-S-C156
3.00-5	Dæk Tyre	●	C 189	3.5	4 PR	D4.10/3.50-4-G-C189
	Dæk Tyre	●	C 920	3.5	4 PR	D3.00-5-G-Racing
3.40/3.00-5	Dæk Tyre	●	C 178	3.5	4 PR	D3.40/3.00-5-G-M
4.00-5 330 x 100	Dæk Tyre	●	C 154	3.5	4 PR	D4.00-5-GB-C154
	Dæk Tyre	●	C 154	3.5	4 PR	D4.00-5-SB-C154
4.10/3.50-5	Dæk Tyre	●	C 154	3.5	4 PR	D4.10/3.50-5-C154
	Dæk Tyre	●	C 154	3.5	4 PR	D4.10/3.50-5-S-C154
	Dæk Tyre	●	C 156	3.5	4 PR	D4.10/3.50-5-G-C156
	Dæk Tyre	●	C 156	3.5	4 PR	D4.10/3.50-5-S-C156
	Dæk Tyre	●	C 189	3.5	4 PR	D4.10/3.50-5-G-C189



C-131 C-156 C-165 C-166 C-168 C-177 C-178 C-179 C-248 C-917

Størrelse Size		 Colour	 BAR		Art-Nr. Art.-No.	
2.00-6 10 x 2	Dæk Tyre	●	C 179	3.5	2 PR	D250/50-G
	Dæk Tyre	●	C 179	3.5	2 PR	D250/50-S
2.50-6	Dæk Tyre	●	C 177	3.5	6 PR	D2.50-6-G-C177
3.00-6	Dæk Tyre	●	C 917	3.5	6 PR	D3.00-6-G-C917
4.00-6	Dæk Tyre	●	C 166	3.5	4 PR	D4.00-6-SB
	Dæk Tyre	●	C 156	2.5	4 PR	D4.10/3.50-6-GB-C156
4.10/3.50-6	Dæk Tyre	●	C 156	2.5	4 PR	D4.10/3.50-6-SB-C156
	Dæk Tyre	●	C 168	2.5	4 PR	D4.10/3.50-6-GB-C168
	Dæk Tyre	●	C 168	2.5	4 PR	D4.10/3.50-6-SB-C168
	Dæk Tyre	●	C 178	2.5	4 PR	D4.10/3.50-6-GB-C178
13 x 5.00-6	Dæk Tyre	●	C 165	3.5	4 PR	D13x5.00-6-GB-CS
	Dæk Tyre	●	C 165	3.5	4 PR	D13x5.00-6-SB
5.30/4.50-6	Dæk Tyre	●	C 166	3.5	4 PR	D5.30/4.50-6-GB-C166
2.50-8	Dæk Tyre	●	C 177	3.5	6 PR	D2.50-8-GB4-CS
	Dæk Tyre	●	C 179	2.5	2 PR	D3.00-8-GR-C179
3.00-8	Dæk Tyre	●	C 248	2.5	4 PR	D3.00-8-SB-C248-4PR
	Dæk Tyre	●	C 248	2.5	4 PR	D3.00-8-GB-CS
	Dæk Tyre	●	C 917	2.5	4 PR	D3.00-8-S-C917-4PR
	Dæk Tyre	●	C 917	2.5	4 PR	D3.00-8-G-C917
Udv. Dia Meter 340 mm	Dæk Tyre	●	C 248	2.5	4 PR	D3.00-8-SB-MC
	Dæk Tyre	●	C 168	3.5	4 PR	D3.50-8-GB4
3.50-8	Dæk Tyre	●	C 131	3.5	4 PR	D3.50-8-SB
	Dæk Tyre	●	C 168	3.5	4 PR	D400/100-GB
4.00-8	Dæk Tyre	●	C 168	3.5	4 PR	D400/100-SB
	Dæk Tyre	●	C 131	2.5	4 PR	D3.00-10-G-C131
3.00-10	Dæk Tyre	●	C 917	2.5	4 PR	D3.00-10-G-C917
	Dæk Tyre	●	C 917	2.5	4 PR	D3.00-10-S-C917
3.50-10	Dæk Tyre	●	C 131	3.5	4 PR	D3.50-10-SB-C131

Det rigtige dæk til den rigtige situation

Uanset hvor i livet du er og uanset din situation er det vigtigt at du kan stå fast.
Derfor er det rigtige dæk valg, også vigtigt for dig.

Hos Rolko Scandinavia har vi et stort udvalg af dæk, til netop dit behov inden for Rehab.

Vi har de førende fabrikater inden for dæk industrien og leverer både traditionelle luft gummi dæk, som også fås i forstærket udgaver for at mindske risikoen for punkteringer.

Foruden de traditionelle luft gummi dæk, har vi hos Rolko gruppen, vores egen produktion af Pur-baner. Pur-baner er komplet punkterfri dæk til manuelle kørestole og kan være med til at øge bevægelses friheden for den enkelte bruger, da man ikke længe skal være opmærksomme på risikoen ved punktering.

Vi har også dæk med fyldninger til både El-kørestole og El-scootere. Disse er også komplet punkterfri og fås i mange størrelser og varianter.



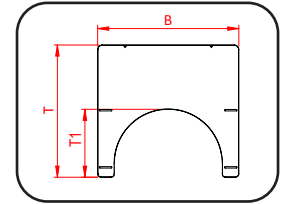
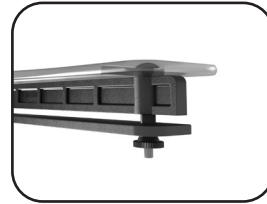

Inkl. beslag til armlæn med tykkelse fra 25 til 31 mm |
Assembly kit for 25-31 mm arm rest attachment included

Terapibord af plast, tykkelse: 6 mm, transparent, inkl. montage-tilbehør |
Therapy table in plastic, thickness: 6 mm, transparent, assembly kit included

B	T	T1	SB	Art-Nr. Art.-No.	HMI Nr
580	590	305	360 - 440	TP580-31	77819
630	590	305	380 - 480	TP630-31	78223
700	590	305	440 - 540	TP700-31	78224

Valgfrit tilbehør | Optional accessories

Montagesæt til terapiborde inkl. 4 flade skruer med rundhoved, 4 tandskiver,
4 riflede fingermøtrikker og 4 afstandsrør | Assembly kit for therapy tables
incl. 4 round-head screws, 4 lock washers, 4 knurled nuts and 4 distance tubes

U-MZT



Med HMI Nr.
www.hmi-basen.dk

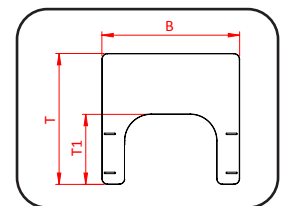

Inkl. beslag til armlæn med tykkelse fra 25 til 31 mm |
Assembly kit for 25-31 mm arm rest attachment included

Terapibord af plast, tykkelse: 8 mm, transparent, inkl. montage-tilbehør |
Therapy table in plastic, thickness: 8 mm, transparent, assembly kit included

B	T	T1	SB	Art-Nr. Art.-No.	HMI Nr
600	570	300	380 - 460	TP-L1	78664
675	570	300	460 - 540	TP-L2	78665
775	570	300	560 - 640	TP-L3	103778

Terapiborde | Therapy Tables

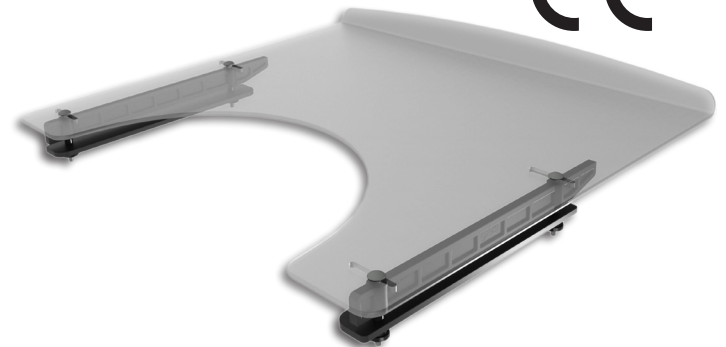
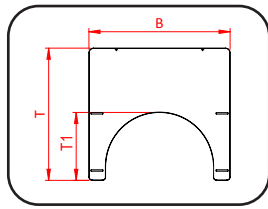
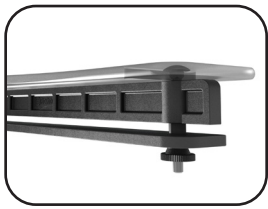

Inkl. beslag til armlæn med tykkelse fra 25 til 31 mm |
Assembly kit for 25-31 mm arm rest attachment included

Terapibord af plast, tykkelse: 5 mm, transparent, med forkant |
Therapy table in plastic, thickness: 5 mm, transparent, with front stop

B	T	SB	Art-Nr. Art.-No.	HMI Nr
650	570	380-480	TP650-31-MK	78667

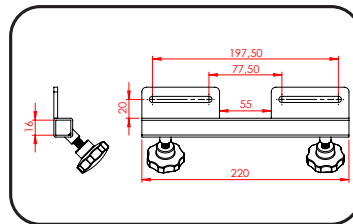
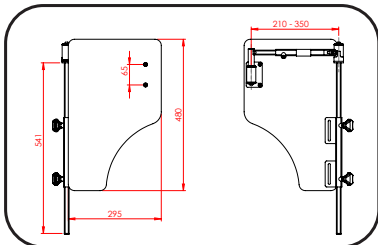
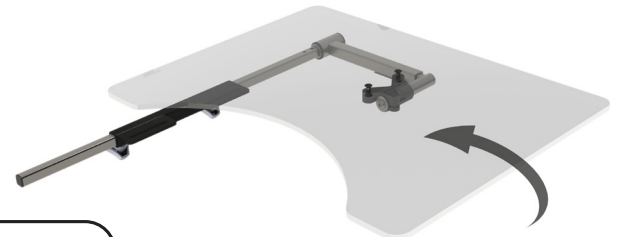
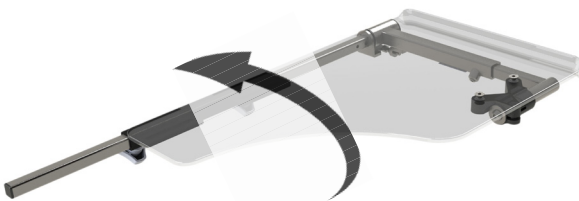

Monteringsadapter til armlæn |
Mounting adapter for arm rests

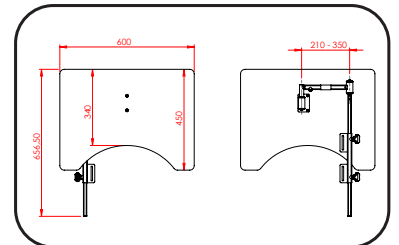

Halvt terapibord af 8 mm plast, transparent, sammenklappeligt, variabel siddebredde, med forbedret holdesystem, kan monteres i venstre og højre side | Half-size therapy table made of 8 mm plastic, transparent, foldable, variable seat width, with improved support system for left and right side

Terapibord af 8 mm plast, transparent, sammenklappeligt, variabel siddebredde, med forbedret holdesystem, kan monteres i venstre og højre side | therapy table made of 8 mm plastic, transparent, foldable, variable seat width, with improved support holdesystem for left and right side

B	T	Art-Nr. Art.-No.	HMI Nr
295	480	TP300-KLP-3	78668



B	T	Art-Nr. Art.-No.	HMI Nr
600	450	TP600-KLP-3	78669

Holdesystem, uden terapibord |
Support system, without therapy table

-	-	HA-TP-KLP-3-1/2
---	---	-----------------

Holdesystem, uden terapibord |
Support system, without therapy table

-	-	HA-TP-KLP-3-1
---	---	---------------

Polster til terapibord.

Fås til både halv og hel
Købes separat

POL-TP-L1
POL-TP-L2



Tilbehør til toiletstole | Toilet Chair Accessories



Universal-toiletsæde af plastik, aftagelig spandholder, åbning: 230x263 mm, f.eks. velegnet til: | Universal toilet seat made of plastic, removable bucket holder, opening: 230x263 mm, e.g. for: Bischoff+Bischoff TS200 / TS1, Ortopedia 5HCDA, Meyra 2176 / 3176

B	T	Art-Nr. Art.-No.	HMI Nr
450	435	TS-O/M	81806



Toiletsæde af plast med spandholder, åbning: 220x255 mm, f.eks. velegnet til: | Toilet seat made of plastic with bucket holder, opening: 220x255 mm, e.g. for: Ruska, Behrendt, Dietz, Invacare H720T, Drive TRS130, Rehaforum Medical

B	T	Art-Nr. Art.-No.	HMI Nr
455	450	TS-M-176N	81807

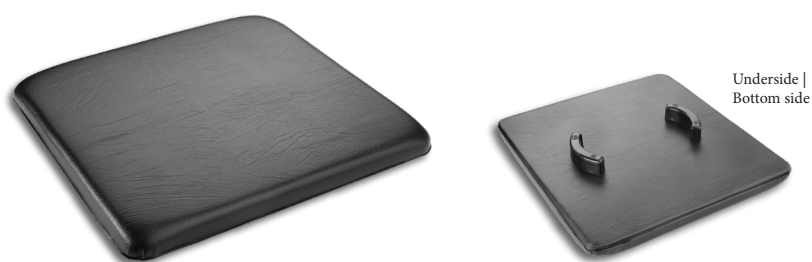

Toiletsædebræt med kunstlæderbetræk og træindlæg | Toilet seat cover with artificial leather cover and wood core

B	T	Art-Nr. Art.-No.	HMI Nr
405	435	TS-AD-KS	81073

Uden træindlæg

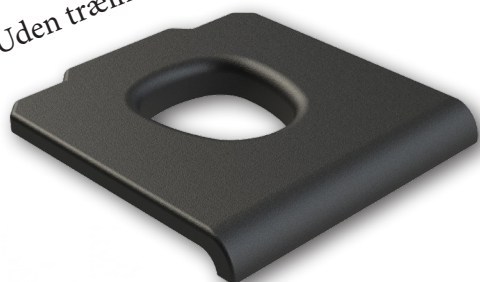

Toiletsædepude, blød, af PU-skum, åbning: 170x190 mm | Toilet seat cushion, soft, made of PU foam, opening: 170x190 mm

B	T	Art-Nr. Art.-No.	HMI Nr
435	450	TS-A-PU	81074

Tilbehør til toiletstole | Toilet Chair Accessories

Toiletspand af plast med låg, vandrille / lugtlås, volumen: ca. 5,5 l. | Plastic toilet bucket with lid, odour trap and gutter, capacity: ca. 5,5 ltr.

316	255	170	E-DE-G	50622

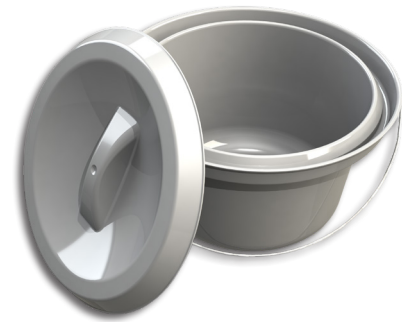

Toiletspand af plast med låg og vakuum-lugtlås, volumen: ca. 5,5 l. | Plastic toilet bucket with lid and vacuum odour trap, capacity: ca. 5,5 ltr.

318	245	180	E-DE-N-G	50621



Gråt rustfrit svinghjul med grå plast gaffel med M12 x 40 / 27 mm bolt. Med signal rød hjul- og retningslås. Byggehøjde 161 mm, Max belastning 100 kg | Stainless wheel with gray plastic fork, M12 x 40 / 27 mm bolt. With red brakepedal for total- and direction brake. Hight 161 mm, Max load 100 kg

Med totalbremse With total lock	125	32	100	R125-841R

Passer til Aquatec Ocean



Rustfri

Gråt rustfrit svinghjul med grå plast gaffel med M12 x 40 / 27 mm bolt. Med marine blå retningslås. Byggehøjde 161 mm, max belastning 100 kg | Stainless wheel with gray plastic fork, M12 x 40 / 27 mm bolt. With blue brakepedal for direction brake. Hight 161 mm, Max load 100 kg

Med Retningslås With direction lock	125	32	100	R125-842R

Passer til Aquatec Ocean





Rustfri

Tysk gennem testet Kvalitets hjul til Hospitals og Plejesenge Vi lagerføre dem i tre typer med og uden retningsbremse/lås

- Maskinel vaskbar og elektrisk ledende.
- 2 lukkede kuglelejer i hjul. Længere levetid på hjul vask efter vask
- Stabil og stærk konstruktion for lang levetid.
- Vi anbefaler disse hjul til Hospitaler.





Sengehjul med lang tap, fremstillet i Polyamid med eb afsmitningsfri TPU bane. Hjulet fås i to varianer, en med Retnings og total lås og en med total lås. hjulet er maskinelt vaskbart og er antistatisk .

				Art-Nr. Art.-No.
Med retning og total-bremse	150	188	150	R150-899W-RT
Med totalbremse With total lock	150	188	150	R150-898W-T





Sengehjul med kort tap, fremstillet i Polyamid med eb afsmitningsfri TPU bane. Hjulet fås i to varianer, en med Retnings og total lås og en med total lås. hjulet er maskinelt vaskbart og er antistatisk .

				Art-Nr. Art.-No.
Med retning og total-bremse	150	188	150	R150-899W-RT-KT
Med totalbremse With total lock	150	188	150	R150-898W-T-KT



Dobbelt sengehjul med kort tap, fremstillet i Polyamid med eb afsmitningsfri TPU bane. Hjulet fås i to varianer, en med Retnings og total lås og en med total lås. hjulet er maskinelt vaskbart og er antistatisk .

				Art-Nr. Art.-No.
Med retning og total-bremse	150	32	150	R150-559W-RT
Med totalbremse With total lock	150		150	R150-558W-T

Infusionsstave | IV Equipment Rods

Med HMI Nr.
www.hmi-basen.dk

Art-Nr. Art.-No.	HMI Nr
MT-IN-RLD	81889

Infusions stav - Guld model
Monteret med 5 antistatiske (ESD) hjul. Kryds med 4 dropholdere max 2kg/stk. Justerbar højde 1350-2150mm.

Fås med plast top eller metal top(tåler autoklaver)



Med klemmegreb, inkl. Fiksering til rør-Ø 22 og 25 mm | With clamping lever, incl. fixation for tube Ø 22 and 25 mm

Art-Nr. Art.-No.	HMI Nr
MT-IN-R22	81885

Med justerbar hældningsvinkel, inkl. Fiksering til rør-Ø 22 og 25 mm | With adjustable tilt angle, incl. fixation for tube Ø 22 and 25 mm

Art-Nr. Art.-No.	HMI Nr
MT-IN-V22/25	81884

Med 2 knækked, inkl. fiksering til rør-Ø 22 og 25 mm | With 2 articulated joints, incl. fixation for tube Ø 22 and 25 mm

Art-Nr. Art.-No.	HMI Nr
MT-IN-SCHV22	87018



Abduktionsklodser og holdesystemer | Abductor Wedges and Restraining Systems

Abduktionsklodsholder, justerbar i højde og dybde, stålplade med 8 monteringspunkter (Ø 5,50 mm) til fiksering under kørestolens siddeflade. MDR godkendt | Restraining system for abductor wedges, height and depth adjustable, steel mounting plate with 8 holes (Ø 5,50 mm) for fixation below the wheelchair seat area

L	Art-Nr. Art.-No.	HMI Nr
80	HA-AK-1	78740
160	HA-AK-2	78741



Abduktionsklodser af polyurethan-skum med trækerne MDR godkendt | Abductor wedges in polyurethane foam with wood core

Størrelse Size	L	B	H	Art-Nr. Art.-No.	HMI Nr
Small	93	66	90	PU-AK-S	78737
Medium	113	82	100	PU-AK-M	78738
Large	128	91	100	PU-AK-L	78739

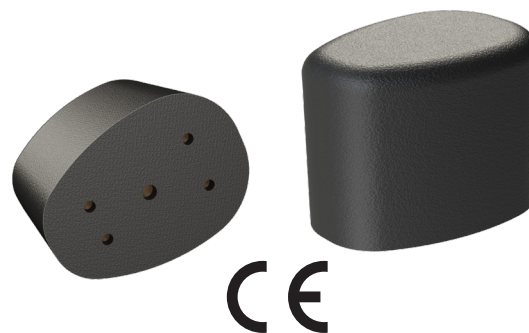
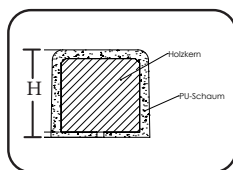
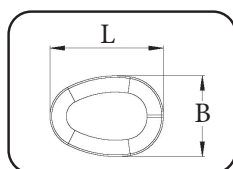

Arm- og benstøtter | Arm and Leg Supports

Pu-skum, trækerne | PU foam, wood core

L	Art-Nr. Art.-No.	HMI Nr
150	PU-W-150-S4/20	81870
200	PU-W-220-S-K	81870

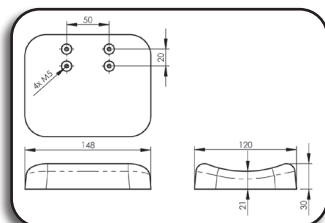

PU-W-150-S4/20

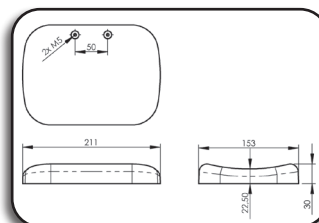

PU-W-220-S-K



Pu-skum, stålkerne | PU foam, steel core

L	Art-Nr. Art.-No.	HMI Nr
258	PU-B-295-S	81804

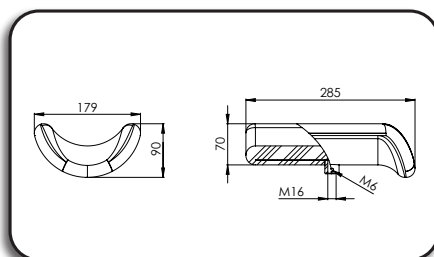

Arm- og benstøtter | Arm and Leg Supports

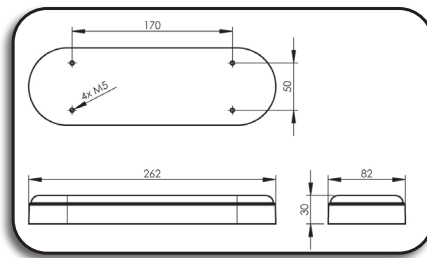

PU-skum, trækerne | PU foam, wood core

L	B	H	Art-Nr. Art.-No.	HMI Nr
262	82	30	PU-AG-260-S	81651

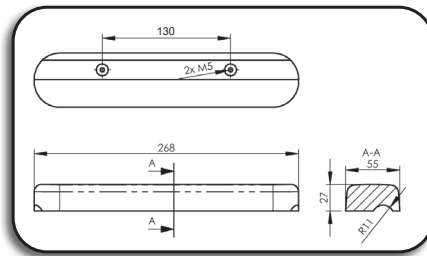
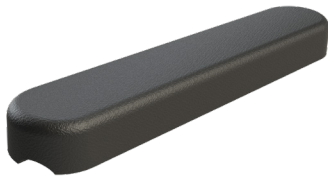

PU-skum, trækerne | PU foam, wood core

L	B	H	Art-Nr. Art.-No.	HMI Nr
270	55	27	PU-AG-270-S130	81653

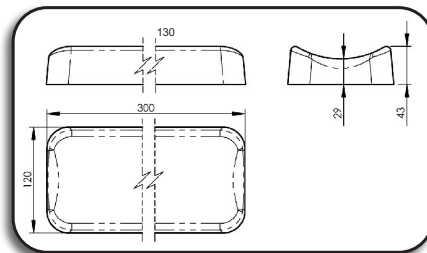

PU-skum, trækerne | PU foam, wood core

L	B	H	Art-Nr. Art.-No.	HMI Nr
300	120	43	PU-A-300-S	81800

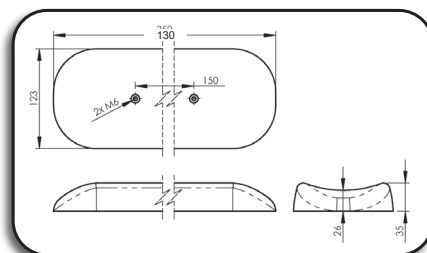
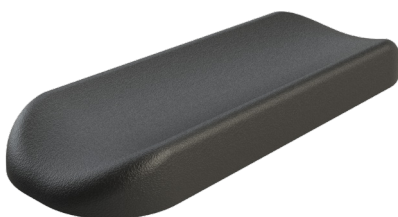

PU-skum, trækerne | PU foam, wood core

L	B	H	Art-Nr. Art.-No.	HMI Nr
350	123	35	PU-A-350-S	81801

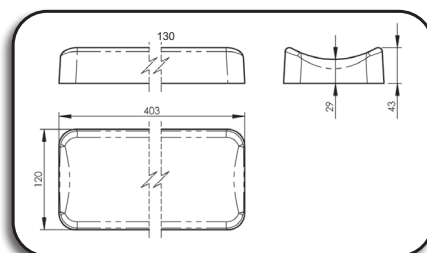

PU-skum, trækerne | PU foam, wood core

L	B	H	Art-Nr. Art.-No.	HMI Nr
400	120	43	PU-A-400-S	81803

Pu-skum, kerne med aluminiumsprofil, 2 løse notsten med gevind M5/M6, variabel hulafstand op til 285 mm. | PU foam, core with aluminium profile, 2 loose groove stones with M5/M6 thread, variable hole distance up to 285 mm.

L	B	H	Art-Nr. Art.-No.
345	48,50	27,5	PU-AG-345-S



Løse notsten M5/M6 |
Loose groove stones M5/M6



PU-skum, trækerne, universal med 2 faste gevindmuffer M5 og 2 løse gevindmuffer M5 til indskræmning i de forborede huller, andre hulafstande er mulige. | PU foam, wood core, universal incl. 2 fixed threaded sockets M5 and 2 loose threaded sockets M5 to screw into the pre-drilled holes, different hole distances possible.

L	B	H	Art-Nr. Art.-No.
360	47,50	24,50	PU-AG-370-S-U

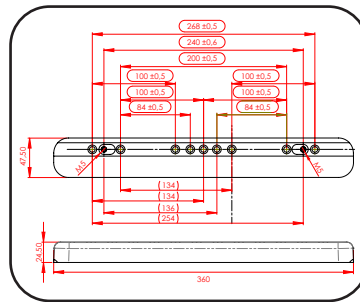

Løse gevindmuffer M5 |
Loose threaded sockets M5



Blødt kunstlæderbetræk, let plastunderdel med 6 gevindmuffer M5. | Soft synthetic leather cover, light plastic lower part with 6 threaded sockets M5.

L	B	H	Art-Nr. Art.-No.
266	58	37	AG-240-SS-6
370	58	37	AG-370-SS-6

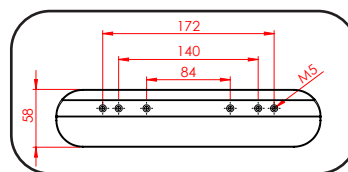

AG-240-SS-6

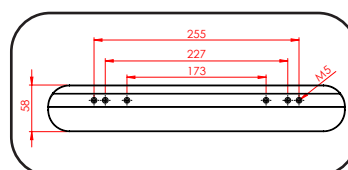

AG-370-SS-6



Medicinske triangelgreb | Medical Trapeze Handles

Med HMI Nr.
www.hmi-basen.dk



EVOlution: Integreret, automatisk optræk for en komfortabel enhåndsbetjening samt skridsikker hængeløkke | Integrated retractor for a comfortable single-hand usage and non-slip hanger

Art-Nr. Art.-No.	HMI Nr
TG-EVO-01	134326

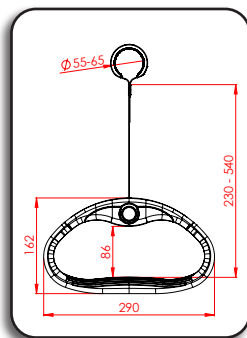

Automatisk optræk og skridsikker hængeløkke | Automatic retractor and non-slip hanger

Art-Nr. Art.-No.	HMI Nr
TGN-R100GR	

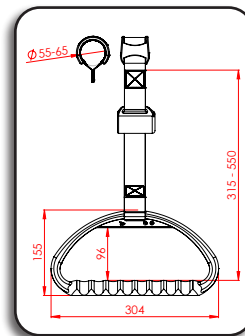

Spænde og skridsikker hængeløkke | Buckle and non-slip hanger

Art-Nr. Art.-No.	HMI Nr
TGN-RSG70	143318

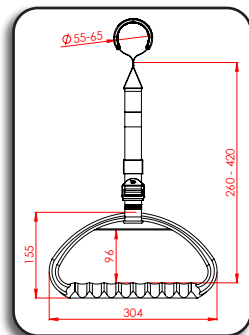

Spænde og skridsikker hængeløkke | Buckle and non-slip hanger

Art-Nr. Art.-No.	HMI Nr
TGE-RSG70-01	143318

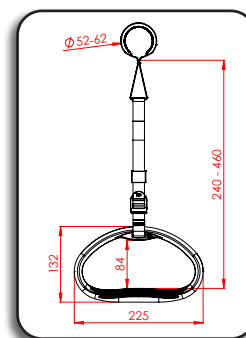

Vores medicinske triangelgreb er certificeret ifølge DIN EN 60601-2-52. og MDR godkendte | Our medical trapeze handles are certified according to DIN EN 60601-2-52.

Hovedstøtter og holdesystemer MDR Godkendt | Head Rests and Restraining Systems

Holdesystemer af aluminium til montering på skubbehåndtag, breddejustering: 400 - 600 mm, højdejustering op til maks. 350 mm. | Aluminium restraining systems for the fixation on push handles, width adjustment: 400 to 600 mm, height adjustment up to 350 mm.

Holdekløer med holder til rør-Ø 22 og 25 mm.
Kuglehovedholder med klemme. |
Clamping jaws for tube Ø 22 and 25 mm. Ball head holder with clamp for the head rest fixation.

Art-Nr. Art.-No.	HMI Nr
HA-UV-KO-S	81070

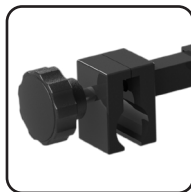

Holder til rør-Ø op til 38 mm. Kuglehovedholder med klemme til montering på hovedstøtte. |
Suitable for tube Ø up to 38 mm. Ball head holder with clamp for the head rest fixation.

Art-Nr. Art.-No.	HMI Nr
HA-UV-KO-38-S	81071



Hovedstøtter af Pu-skum med aluminiumskerne og holder til kuglehoved-Ø 25 mm |
Head rests made of PU foam with aluminium core and receiver for ball head with Ø 25 mm

Art-Nr. Art.-No.	HMI Nr
PU-KO-5-S	77302

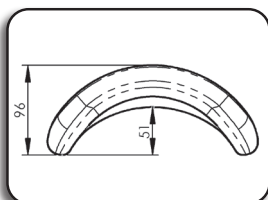
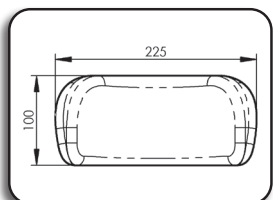

Art-Nr. Art.-No.	HMI Nr
PU-KO-6-S	77432

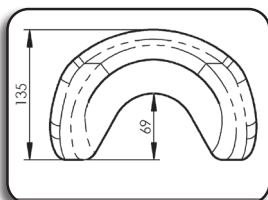
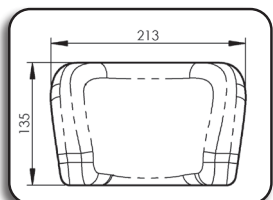

Art-Nr. Art.-No.	HMI Nr
PU-KO-7-S	77433

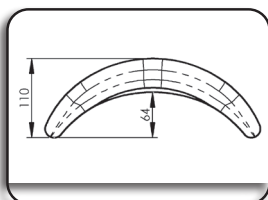
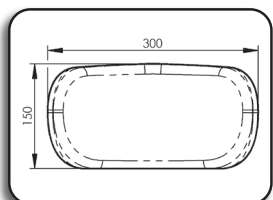

Hovedstøtter og holdesystemer MDR Godkendt | Head Rests and Restraining Systems

3D side- og højdejusterbare | 3D side and height adjustable

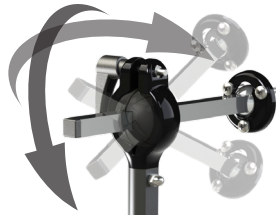

Holdesystemer af aluminium med monteringsplade til fiksering på sæderyggen. | Aluminium restraining systems with mounting plate for fixation on seat back.

3D-kugleled, højdejusterbar op til 400 mm, inkl. kuglehoved med klemme. | 3D ball-joint, height adjustable up to 400 mm, incl. ball head with clamp.

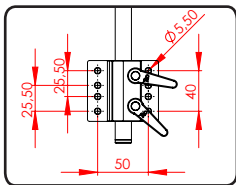

Monteringsplade | Mounting plate

Art-Nr. Art.-No.	HMI Nr
HA-KO-ALU-KG	77294



Svanehals, højdejusterbar indtil 350 mm, inkl. kuglehoved med klemme. | Gooseneck, height adjustable up to 350 mm, incl. ball head with clamp.

Art-Nr. Art.-No.	HMI Nr
HA-KO-ALU-R	77292



3D side- og højdejusterbare | 3D side and height adjustable



Holdesystemer af aluminium med holdeklo til montering på skubbehåndtag (bredde: 380 - 550 mm), velegnet til rør-Ø 22 / 25 mm. | Aluminium restraining systems with retaining claw for push rim fixation (width: 380 - 550 mm), suitable for tube Ø 22 / 25 mm.

3D-kugleled, inkl. Kuglehoved med klemme. | 3D ball-joint, incl. ball head with clamp.

Klemme Clamp	Art-Nr. Art.-No.	HMI Nr
22	HA-KO-ALU-KG-C22	77291
25	HA-KO-ALU-KG-C25	77293



Holdeklo | Fixation claw

Svanehals, inkl. kuglehoved med klemme. | Gooseneck, incl. ball head with clamp.

Klemme Clamp	Art-Nr. Art.-No.	HMI Nr
22	HA-KO-ALU-C22	50620
25	HA-KO-ALU-C25	77301



Sidestøtte og holdesystemer MDR Godkendt | Side Pads and Restraining Systems

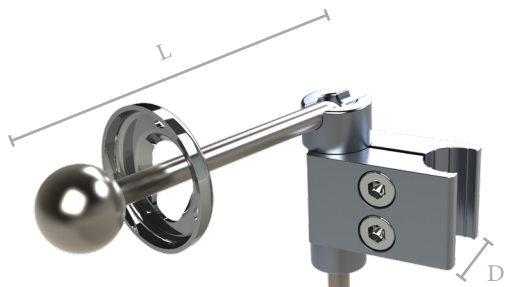

CE

Drejestænger af rustfrit stål med kuglehoved-Ø 25 mm, klo til rør-Ø 22 / 25 mm | Swivel bars in stainless steel with ball head Ø 25 mm, clamp for tube Ø 22 / 25 mm

L	B	Art-Nr. Art.-No.
95	22	U-BE-SP95-HA22
165	22	U-BE-SP165-HA22
95	25	U-BE-SP95-HA25
165	25	U-BE-SP165-HA25



Forside | Front side



Bagside | Back side

CE

Sidepelletter af polyurethan-skum med aluminiumsindlæg og kuglehovedholder-Ø 25 mm til montering på holderen, inkl. 6 gevind M5 | Side pads in polyurethane foam with aluminum insert and Ø 25 mm ball head retainers for fixation on holder, incl. 6 threads M5

L	B	Art-Nr. Art.-No.	HMI Nr
165	100	PU-SP-165x100-S	80309
205	125	PU-SP-205x125-S	80303
235	150	PU-SP-235x150-S	80305

Med HMI Nr.
www.hmi-basen.dk



Forside | Front side

CE



Bagside | Backside

Sidepelletter af polyurethan-skum med stålindlæg og gevindmuffe M6 | Side pads in polyurethane foam with steel insert and threaded socket M6

L	B	Art-Nr. Art.-No.	HMI Nr
130	85	PU-SP-130x85-S-M6	80306
165	100	PU-SP-165x100-S-M6	80309

Sidestøtte og holdesystemer MDR Godkendt | Side Pads and Restraining

Hængsler Junior af aluminium med betjeningsknap, 180° drejeligt led og monteringsplader | Aluminium hinges Junior with operating button, 180° rotatable joint and mounting plates

L1	L2	Side Side	Art-Nr. Art.-No.
100	130	Venstre Left	HA-SP-ALU-J-100-SL130
100	130	Højre Right	HA-SP-ALU-J-100-SR130
100	200	Venstre Left	HA-SP-ALU-J-100-SL200
100	200	Højre Right	HA-SP-ALU-J-100-SR200

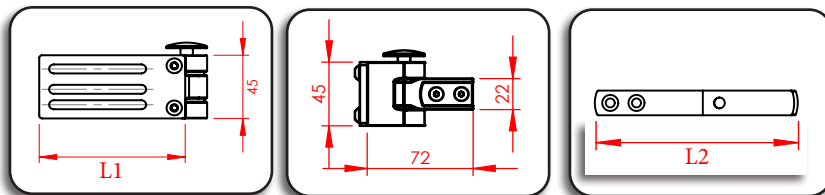
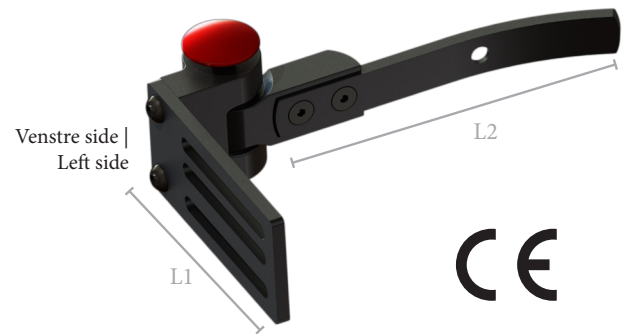

Hængsler af aluminium med betjeningsknap, 180° drejeligt led og monteringsplader | Aluminium hinges Junior with operating button, 180° rotatable joint and mounting plates

L1	L2	Side Side	Art-Nr. Art.-No.
100	130	Venstre Left	HA-SP-ALU-100-SL130
100	130	Højre Right	HA-SP-ALU-100-SR130
100	200	Venstre Left	HA-SP-ALU-100-SL200
100	200	Højre Right	HA-SP-ALU-100-SR200

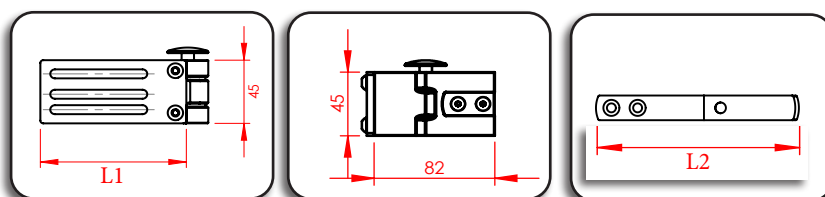
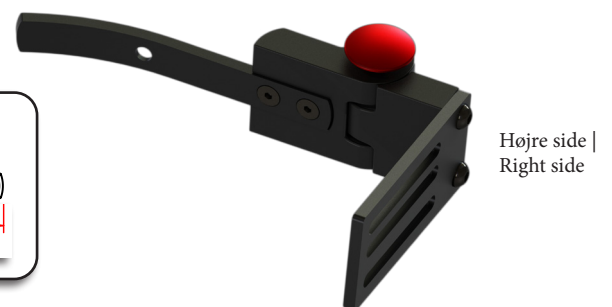
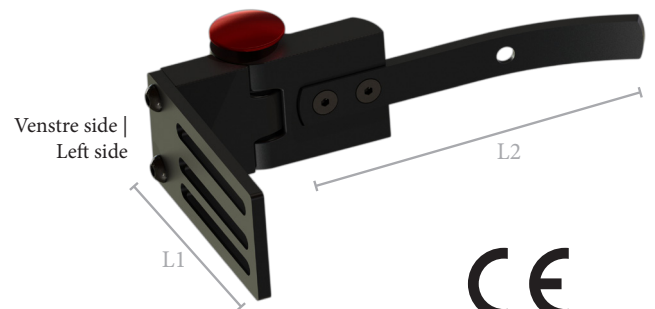

Modulært armstøttesystem HEMI MDR Godkendt | Modular Arm Shell System HEMI

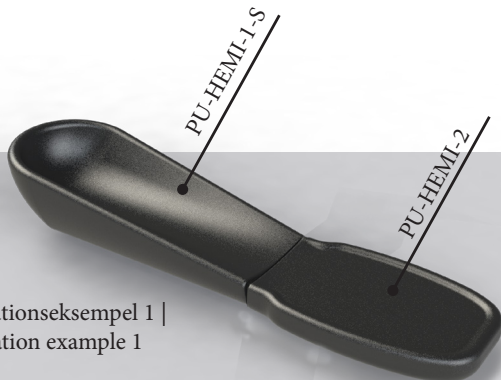

Kombinationseksempel 1 |
Combination example 1

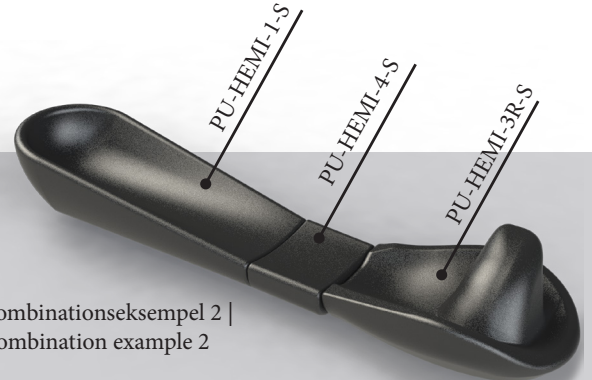

Kombinationseksempel 2 |
Combination example 2

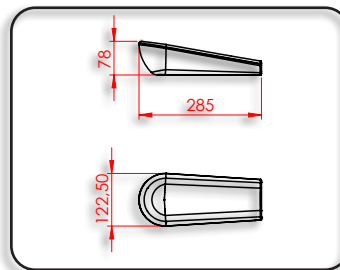

Skål med notsten for en optimal stabilisering og positionering af underarmen | Support with slot nuts for an optimal forearm stabilisation and positioning

Art-Nr. Art.-No.	HMI Nr
PU-HEMI-1-S	103838

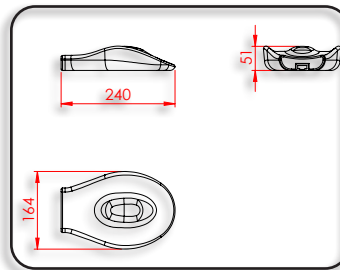

Universal komfort-håndstøtte inkl. tilslutningsplade med 4 gevindstifter | Universal comfort hand rest incl. connecting plate with 4 grub screws

Art-Nr. Art.-No.	HMI Nr
PU-HEMI-5	

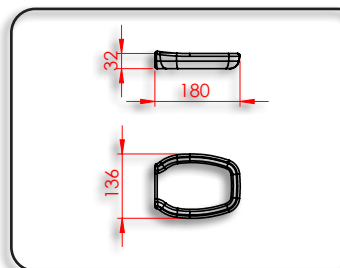

Håndstøtte inkl. tilslutningsplade med 4 gevindstifter | Arm rest incl. connecting plate with 4 grub screws

Art-Nr. Art.-No.	HMI Nr
PU-HEMI-2-S	103840



Venstre | Left

Højre | Right

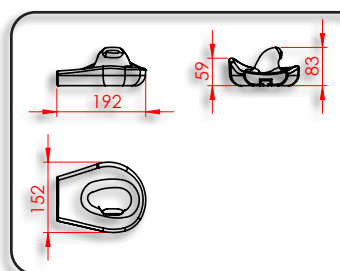

Komfort-håndstøtte inkl. tilslutningsplade med 4 gevindstifter | Comfort hand rest incl. connecting plate with 4 grub screws

	Art-Nr. Art.-No.	HMI Nr
Venstre Left	PU-HEMI-3L-S	103842
Højre Right	PU-HEMI-3R-S	103843

Modulært armstøttesystem HEMI MDR Godkendt | Modular Arm Shell System HEMI

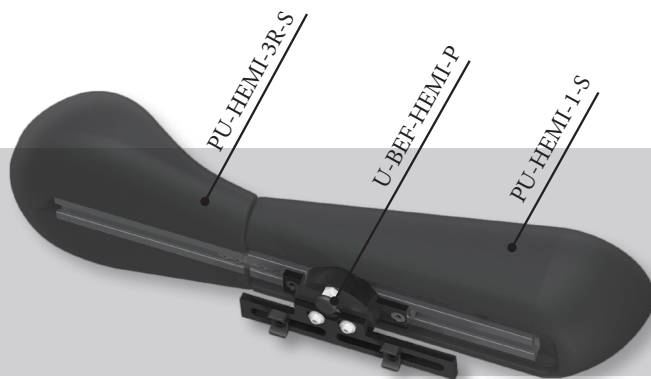

Scan koden for video vejledning



Forlængelsesstykke inkl. tilslutningsplade med 4 gevindstifter | Extension piece incl. connecting plate with 4 grub screws

Art-Nr. Art.-No.	HMI Nr
PU-HEMI-4-S	103839

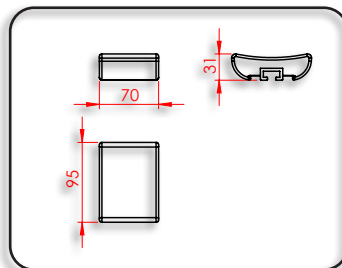

Monteringsenhed, kan drejes 360°, med adapter til runde rør til montering på sidedele på kørestolen, kan monteres til venstre og højre, inkl. 2 notsten, fremspring 17,5 mm, hulafstand 141 mm | Fixation unit, 60° turnable swivel arm, with round tube adapter for attachment on wheelchair side parts, mountable on the left or right side, incl. 2 slot nuts, outreach 17.5 mm, hole distance 141 mm

Art-Nr. Art.-No.	HMI Nr
U-BEF-HEMI-P	

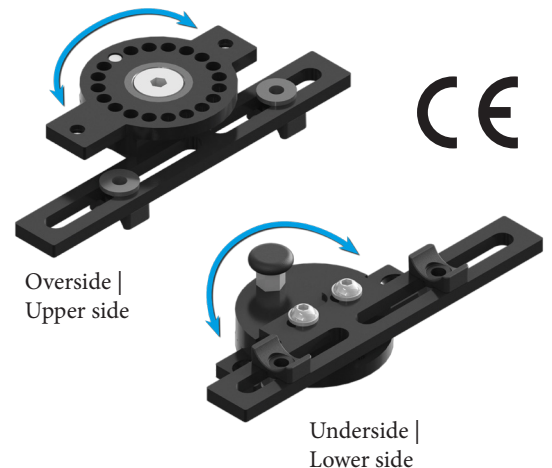
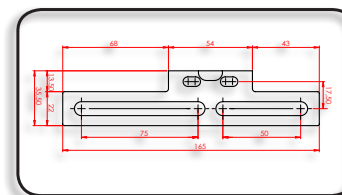
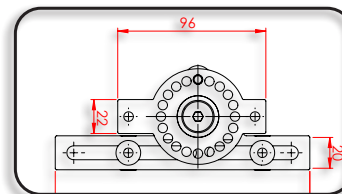

Ekstra holdeplade, fremspring 37,5 mm, hulafstand 141 mm | Additional support plate, outreach 37.5 mm, hole distance 141 mm

Art-Nr. Art.-No.
U-BEF-HEMI-P-2

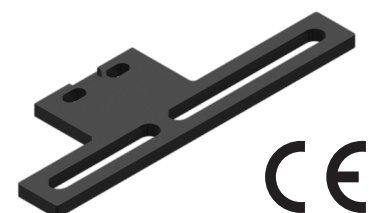
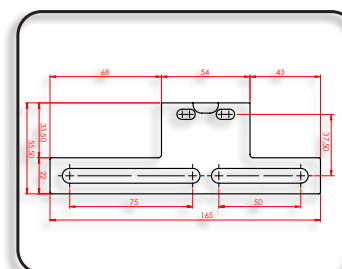

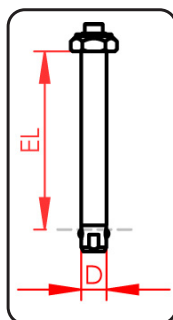

Rustfri Quick Release-akslar | Quick release axles

L	Ø	EL	Art-Nr. Art.-No.
98	12	80	QRA-98-V2A-SA
98	1/2"	80	QRA-98-1/2-V2A-SA
103	12	80	QRA-103-V2A-SA
104	1/2	80	QRA-1/2-V2A-SA
110	1/2"	80	QRA-110-1/2-V2A
113	12	80	QRA-113
123	1/2"	80	QRA-123-1/2-V2A
130	12	80	QRA-130-V2A

Komplet rustfri Quick Release-akslar | Quick release axles

85	12	80	QRA-85-KVA
98	12	80	QRA-98-KVA
103	12	80	QRA-103-KVA
123	12	80	QRA-123-KVA

Klemmegreb med møtrik | Clamping lever with female thread



L	Ø	Art-Nr. Art.-No.
50	M6	KH-M6-50
75	M6	KH-M6-75
75	M8	KH-M8-75

Den komplet rustfri aksel egner sig godt til bade og vådrums hjælpemidler.

Klemmegreb med skrue | Clamping lever with male thread



L	Ø	Art-Nr. Art.-No.
50	M5x10	KH-M5x10-50
50	M6x15	KH-M6x15-50
50	M6x20	KH-M6x20-50
50	M6x25	KH-M6x25-50
50	M6x45	KH-M6x45-50
75	M8x20	KH-M8x20-75
75	M8x25	KH-M8x25-75
75	M8x40	KH-M8x40-75
75	M8x50	KH-M8x50-75
90	M10x40	KH-M10x40-92

Dækkapper til nav | Hub cover caps



KN-S-28E-REV
Elastisk | Elastic



KN-S-32/12

Ø	Art-Nr. Art.-No.
28*	KN-S-28E-REV
M12*	KN-S-32/12

*Til navdiameter | For hub diameter

Afstandsrør, galvaniseret, slebet med vibrationspolering, sæt med 50 stk. | Spacer bushing, galvanized, deburring through barrel finishing, set with 50 pcs.

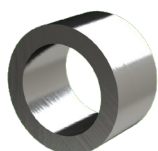

Ø	Ø	EL	Art-Nr. Art.-No.
12	8	3	DR-12x2x3Z
12	8	4	DR-12x2x4Z
12	8	5	DR-12x2x5Z
12	8	6	DR-12x2x6Z
12	8	12	DR-12x2x12Z

Montagetilbehør | Assembly Accessories

Kuglelejer | Ball bearings

		B	Typ Type	Art-Nr. Art.-No.	
28,6 (1.1/8")	12,7 (1/2")	8	R8 2RS	KG-PK-1/2-R8	Rustfri
28,6	1/2"	8	-	KG-PK1/2"	
28	1/2"	8	-	KG-PK1/2"-28-RS	
32	1/2"	8	-	KG-PK1/2-32-RS	
22	10	6	6900 2RS	KG-PK10-22-2RS	
26	10	8	6000 2RS	KG-PK10-26-2RS	
26	10	8	6000 2RS	KG-PK10-26-2RS-VA	Rustfri
28	12	8	6001 2RS	KG-PK12-28-2RS	
28	12	8	6001 2RS	KG-PK12-28-2RS-SS	Rustfri
32	12	10	6201 2RS	KG-PK12-32-2RS	
32	12	10	6201 2RS	KG-PK12-32VA	Rustfri
28	15	7	6902 2RS	KG-PK15-28-2RS	
32	15	11	6002 2RS	KG-PK15-32-2RS	
32	15	9	6002 2RS	KG-PK15-32-2RS-SS	Rustfri
35	15	11	6202 2RS	KG-PK15-35-2RS	
35	17	10	6003 2RS	KG-PK17-35-2RS	
40	17	12	6203 2RS	KG-PK17-40-2RS	
32	20	7	6804 2RS	KG-PK20-32-2RS	
37	20	9	6904 2RS	KG-PK20-37-2RS	
37	20	9	6904 2RS	KG-PK20-37-2RS-SS	Rustfri
42	20	12	6004 2RS	KG-PK20-42-2RS	
47	20	14	6204 2RS	KG-PK20-47-2RS	
47	25	12	6005 2RS	KG-PK25-47-2RS	
22	8	7	608 2RS	KG-PK8-22-2RS	
22	8	7	608 2RS	KG-PK8-22-2RS-VA	Rustfri

Unbrakoskrue til plastforlængelse 40 mm, antal: 100 stk. Kan bestilles enkeltvis. | Socket head screw for plastic extension 40 mm, quantity 100 pc. Single quantity also available.

	Art-Nr. Art.-No.
M10x60	U-S-912-M10x60



Rørfikseringer | Tube fixations

L			Art-Nr. Art.-No.
48	18-20*	M10	U-EX-R18-20
48	21-23*	M10	U-EX-R21-23

*Til indvendig rørdiameter | For tube inner diameter



Plastforlængelser | Plastic extensions

L		Art-Nr. Art.-No.
40	22	U-GV-40
40	25	U-GV-25-40
70	22	U-GV-70
70	25	U-GV-25-70

Unbrakoskrue til plastforlængelse 70 mm, antal: 100 stk. Kan bestilles enkeltvis. | Socket head screw for plastic extension 70 mm, quantity 100 pc. Single quantity also available.

	Art-Nr. Art.-No.
M10x100	U-S-912-M10x100





www.Rolkoshop.dk

Rolko Scandinavia

Rolko er en af de største spillere indenfor hjælpemiddelbranchen i verden, men vi er lokalt forankrede på vores respektive markeder, og mener at vi dermed kan yde den bedste service for vores kunder.

Vi er underleverandør til utallige producenter og vi er helt i top, når det kommer til salg af reservedele og tilbehør på eftermarkedet i Europa. Vi har herudover også et ret stort produktprogram der sælges til øvrig industri.

Hovedkontoret er beliggende i Tyskland, og der er datterselskaber i Danmark, Holland, Kina og USA.

I alt er vi over 200 dedikerede medarbejdere.

Vores mål er at skabe værdi for vores kunder via fornuftige priser, kort leveringstid og som en stabil og fleksibel leverandør. Vores danske afdeling har eksisteret siden slutningen af 1998, og består i dag af 4 medarbejdere med tilsammen 50 års branche erfaring.

Vi ønsker at være samarbejdspartner, og gør hvad dér er muligt for at hjælpe vores kunder med opgaver de måtte stå med. Vores løsningsorienterede tilgang er en af vores forcer, og de mange år i branchen og en meget stor berøringsflade gør, at vi ofte kan finde løsninger på diverse opgaver.

Rolko gruppens vision:

Vi vil være en troværdig, innovativ, kvalitetsbevidst og global funderet partner for producenter af hjælpemidler, samt den foretrukne leverandør af reservedele og tilbehør til eftermarkedet.

Rolko Scandinavia ApS

Suensonsvej 2

8600 Silkeborg

Tlf. 87 20 18 88

info@rolko.dk